



MAKE  
SOMETHING  
WONDERFUL

$$\int_0^{\text{Wonderful}} \text{make}(x) dx = \text{snapmaker}$$

snapmaker

Artisan 3-in-1 3D Printer

# QUICK START GUIDE

3D Printing

Laser Engraving and Cutting

CNC Carving and Cutting

"We are all in the gutter, but some of us are looking at the stars."  
— Oscar Wilde



## Make Something Wonderful

We made our debut on Kickstarter in 2017 with Snapmaker Original 3-in-1 3D printer, innovatively integrating three fabrication methods—3D Printing, Laser Engraving and Cutting, and CNC Carving into the body of one machine.

Over these years, we have witnessed so many users deeply love and benefit from the design of 3-in-1. At the same time, we have recognized the need for better performance of each module, even higher quality, and a more user-friendly experience. Therefore, in 2020, we started to plan on a product that can redefine the capability of a 3-in-1 3D printer. And we brought Artisan to the table—the strongest 3-in-1 3D printer in Snapmaker history.

Ideal for beginners and professionals at all levels, Artisan is the result

of 516 days of work vastly improving Snapmaker's flagship product Snapmaker 2.0. It can meet the needs of different fabrication scenarios and truly turn your desktop into a workshop. The high quality and excellent performance that Artisan has to offer can unleash your creativity.

Some of you might be curious about why we named our latest generation of 3-in-1 3D printer as Artisan. For us, Artisan stands for an attitude of exquisite workmanship. To be an Artisan, one has to have the wildest ideas. To be an Artisan, one also has to be down to earth. Snapmaker's mission and vision is to enable everyone to create freely in the real world. We believe our users value the ability to "make" as much as we do. We believe Artisan can be a versatile helper by your side and make you an Artisan of our time.

As creatives, we all desire to make something wonderful, and creativity makes us feel alive. Congratulations on becoming part of the Snapmaker community! Tens of thousands of people like you are using the Snapmaker to explore, make, and share in the world of making. We believe that wonderful things will happen when creative minds meet the ideal tools. Have fun making and see you in our community!

Snapmaker Team

Welcome  
to the World  
of Making



## Happy Making

This machine is built for innovators. Our goal is to assist you to make the world a better place with a machine we built with love. The project could be as small as a Christmas gift, or as ambitious as exploring unknown territories of our mankind. Dream big and make it happen.



## Modular Design

It is not only a 3D printer, but also a powerful machine that you can customize with the provided toolheads and newly-released addons. You can equip your Artisan with a Rotary Module to know about the magic of the 4-axis machining, an Air Purifier for a safer creating experience, or a CAN Hub to enable much more addons to work simultaneously... You define your Artisan the way you like.

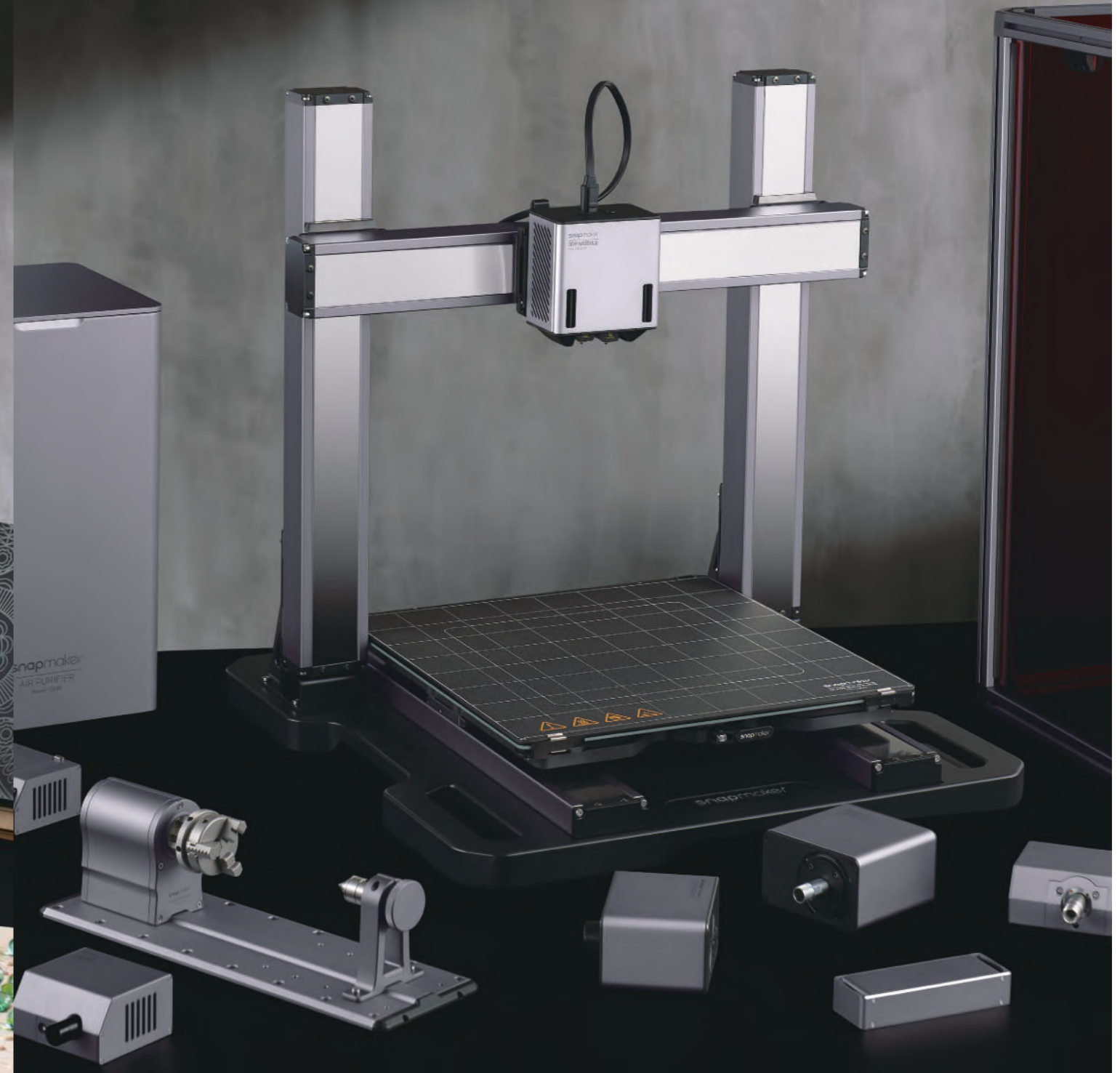

# CONTENTS

- Before You Start ..... 1**
- 1.1 Disclaimer..... 2
- 1.2 Intended Use..... 2
- 1.3 Safety Information & Compliance..... 3
- 1.4 Safety Labels on Your Snapmaker..... 8
- 1.5 Specifications..... 10
- 1.6 Parts List..... 12
- 1.7 Used Symbols..... 16
- 1.8 Tips & Notes..... 16
- 1.9 Common Operations..... 17
- 1.10 About This Guide..... 19
  
- Machine Assembly ..... 20**
  
- Enclosure ..... 44**
- 3.1 Enclosure Assembly..... 46
- 3.2 Enclosure Settings..... 81
  
- 3D Printing ..... 86**
- 4.1 3D Printer Assembly..... 87
- 4.2 Preparations..... 98
- 4.3 Getting Started..... 103
  
- Laser Engraving and Cutting ..... 110**
- 5.1 Laser Engraver and Cutter Assembly..... 111
- 5.2 Preparations..... 118
- 5.3 Getting Started..... 125
  
- CNC Carving and Cutting ..... 132**
- 6.1 CNC Carver and Cutter Assembly..... 133
- 6.2 Preparations..... 140
- 6.3 Getting Started..... 146
  
- Maintenance ..... 156**
- 7.1 3D Printing..... 158
- 7.2 Laser Engraving and Cutting..... 164
- 7.3 CNC Carving and Cutting..... 165

# Before You Start



## 1.1 Disclaimer

Make sure that anyone who uses this product knows and understands the contents of the Quick Start Guide. Failure to observe this guide may lead to personal injury, inferior results, or damage to the Snapmaker products. Snapmaker does not assume responsibility and expressly disclaims liability for any personal injury, inferior results, or damage to the product arising out of or in connection with your improper operations or failure to follow the instructions of the guide.

When using Snapmaker products, you should comply with the following requirements:

- Follow the instructions of this guide, the applicable laws and regulations, and the safety regulations in the assembly, handling, storage, use, maintenance, or disposal of this product.
- Ensure there is no infringement on any third-party intellectual property rights or violation of any applicable laws or regulations when making objects using this product.

The conditions or methods of using Snapmaker products are beyond the control of Snapmaker. For this reason, Snapmaker does not assume responsibility and expressly disclaims liability for any consequences resulting from:

- your improper methods, failure to follow the instructions of this guide or impacts of other uncertain factors when operating this product;
- your infringement on any third-party intellectual property rights or violation of any applicable laws or regulations when making objects using this product;
- personal injury, inferior results, or damage to the product arising out of or in connection with the assembly, handling, storage, use, maintenance, or disposal of this product.

All the Snapmaker filaments and materials are compatible with this product and have been tested for safety. If you use this product with third-party filaments or materials, Snapmaker does not assume responsibility and expressly disclaims liability for any adverse effects from the use or performance of these filaments and materials.

This manual is provided for reference purposes only. We do not warrant the absolute accuracy or completeness of the information provided by this manual. No part of this guide may be reproduced, edited, or revised by any means without the prior written permission of Snapmaker. We reserve the right to modify or revise this manual in our sole discretion at any time without notice. You can download the most up-to-date version of this manual at our Support Center (<https://support.snapmaker.com/>): select **Snapmaker Artisan** > **Quick Start Guide**.

## 1.2 Intended Use

Snapmaker modular 3D printers are intended for use under the guidelines provided in this guide. When making objects using Snapmaker modular 3D printers, users remain responsible to qualify and validate the application of the created object for its intended use, especially for applications in strictly regulated areas like medical devices and aeronautics.

## 1.3 Safety Information & Compliance

### 1.3.1 General Safety Information

- Follow the applicable local laws and regulations in the operation and application of this product.
- Follow the instructions of the guide to use and maintain this product for safety purposes.
- Do not expose this machine to rain or wet conditions.
- Always operate this machine indoors on a solid horizontal table or workbench.
- Minors are only allowed to use this product under adult supervision and assistance.
- Ensure that bystanders also read and understand all the safety notes of this product and keep bystanders away while operating this product for safety purposes.
- Stay alert, watch what you are doing, and pay attention to the surrounding environment when operating this product.
- Do not use this product while you are tired or under the influence of drugs, alcohol, or medication.
- Do not reach inside the product or touch the moving parts while the product is still in operation.
- Do not leave the product unattended while it is still powered on.
- Always unplug the power cable from the electrical outlet before performing maintenance or modifications.

In all EU member states and UK, operation of 5150-5250 MHz is restricted to indoor use only.



**Turn off the machine immediately and stop using this product if any of the following occurs:**

- You smell burning in this product at any point.
- You see any damage to the interior components of this product.
- The machine stops working unexpectedly.
- Unusual lights, sparks, or sounds come out of this product which has never occurred previously.

### 1.3.2 3D Printing Safety Information

- Do not touch the nozzle, the glass build plate, and the heated bed when the machine is printing, heating, or just finished printing.
- Use the 3D Printing Module together with the Snapmaker Enclosure (hereafter Enclosure).
- Use this product in combination with air purifying devices or in a well-ventilated environment, for some filaments and materials may release toxic odors or fumes when melted.
- Always check the safety data sheet of each specific filament and material for safety information before use. You might need to take additional safety measures when using this product with third-party filaments or materials.

### 1.3.3 Laser Safety Information

- The 10W Laser Module is a Class 4 laser product. When you use the laser module correctly and in combination with the Enclosure as required, the overall laser classification of this product is Class 1.
- You should operate this product only if you have sufficient knowledge of (i) the physical properties of laser radiation, (ii) Laser Hazard Classes and associated health implications, and (iii) safety measures.
- The 10W Laser Module must be used together with the Enclosure. Please follow this guide to assemble and use the Enclosure. During laser processes, the Enclosure helps to prevent the risk of laser leakage by effectively filtering laser radiation and pausing the ongoing job if the Enclosure door is opened.

- An air purifier should be used depending on the type and constituent of the materials you are going to use, as some materials may release hazardous and toxic fumes when laser engraved or cut. Ensure that the air purifier you choose is effective enough to protect human health and prevent environmental pollution.
- Do not directly look at or touch the laser aperture or expose yourself to the laser beam during operation.
- Ensure that there is no reflective material within the work area during operation, as it may cause scattered radiation and poses safety risks.
- Ensure that there is no flammable and explosive material within the work area or around the machine during operation, as it may cause a fire.
- The 10W Laser Module mustn't be used with the 3D printing platform and the CNC carving and cutting platform (allowed only in the 4-axis machining scenario, for the Rotary Module can only be attached to the CNC platform). Otherwise, it might damage the mismatched work platform, cause a fire, or pose other risks.

### 1.3.4 CNC Safety Information

- Users of the CNC Module should be at least 18 years old and have relevant experience.
- Use the CNC Module together with the Enclosure.
- All the users and bystanders must wear the CNC safety goggles during operation.
- Before a CNC process, make sure to securely clamp the material.
- During a CNC process, never attempt to hold the workpiece with your hands.
- If the bit or workpiece becomes jammed or bogged down, turn off the machine immediately. Wait for all the moving parts to stop, unplug the cable, and then work to free the jammed material.
- Do not touch the bit or the collet right after use, as doing so could cause burn injuries.
- The toxic substances contained in some materials might be released in CNC carving and cutting processes. To reduce the harm, use the CNC Module with air purifying devices or in a well-ventilated environment and take safety precautions, such as wearing a mask.

### 1.3.5 Enclosure Safety Information

- To move the Enclosure or the machine, you must first separate the machine and the Enclosure under the instructions in the User Manual (which is available at our Support Center: select **Snapmaker Artisan > User Manual**).
- Do not scrape, bend or break the acrylic panels, profiles, or the door handle. Doing so can compromise protection, cause permanent damage to the Enclosure, or even cause personal injuries.
- Do not place the Integrated Controller inside the Enclosure when using this product.
- Do not place objects that weigh more than 7 kg on top of the Enclosure. Otherwise, the top panel will be damaged.
- Do not put any objects or body parts into the exhaust fan when the fan is operating.
- Keep the cables away from the exhaust fan blades to avoid damaging the exhaust fan or other parts of this product.

### 1.3.6 Emergency Measures and Precautions

#### Burns from Hot Surface

Touching hot surfaces (including the heated nozzle, hot end, heated bed, glass build plate, and melting filament) could cause skin burns. If you are burnt, take the following measures immediately:

1. Get yourself away from the heat source;
2. Immediately rinse your burnt area with cool running water;
3. Remove any clothing or jewelry near your burnt area;
4. Wrap the burnt area with a clean, dry bandage;

5. If necessary, use pain relievers or seek medical help immediately.

#### Inhalation of Fumes and Granules

- Fumes, smoke, or granules that irritate your respiratory system might be generated during 3D printing, laser, or CNC processes. Therefore, we recommend using this product with air-purifying devices or in a well-ventilated environment. Wear protective masks if necessary.
- In case of respiratory irritation and other similar symptoms, immediately expose the patient to fresh air and arrange for medical attention in time.

#### Exposure to Irritants

Some soluble filaments might be irritating to the human body. Before exposing yourself to such filaments, always check the safety data sheet (SDS) provided by their manufacturers and take safety precautions.

### 1.3.7 FCC Compliance

This device complies with part 15 of the FCC Rules. Operation is subject to the following two conditions: (1) This device may not cause harmful interference, and (2) this device must accept any interference received, including interference that may cause undesired operation.

Note: This equipment has been tested and found to comply with the limits for a Class B digital device, pursuant to part 15 of the FCC Rules. These limits are designed to provide reasonable protection against harmful interference in a residential installation.

This equipment generates, uses and can radiate radio frequency energy and, if not installed and used in accordance with the instructions, may cause harmful interference to radio communications. However, there is no guarantee that interference will not occur in a particular installation.

If this equipment does cause harmful interference to radio or television reception, which can be determined by turning the equipment off and on, the user is encouraged to try to correct the interference by one or more of the following measures:

- Reorient or relocate the receiving antenna.
- Increase the separation between the equipment and receiver.
- Connect the equipment into an outlet on a circuit different from that to which the receiver is connected.
- Consult the dealer or an experienced radio/TV technician for help.

Caution: Changes or Modifications not expressly approved by the party responsible for compliance could void the user's authority to operate the equipment.

FCC Radiation Exposure Statement: This equipment complies with FCC radiation exposure limits set forth for an uncontrolled environment. This equipment should be installed and operated with a minimum distance of 20 cm between the radiator and your body.

### 1.3.8 ISED Compliance

This device contains license-exempt transmitter(s)/receiver(s) that comply with Innovation, Science and Economic Development Canada's license-exempt RSS(s). Operation is subject to the following two conditions: (1) This device may not cause interference.

(2) This device must accept any interference, including interference that may cause undesired operation of the device.

Operation of 5150-5250 MHz is restricted to indoor use only.

The device complies with RF exposure guidelines, users can obtain Canadian information on RF exposure and compliance. The minimum distance from the body to use the device is 20 cm.

L'émetteur/récepteur exempt de licence contenu dans le présent appareil est conforme aux CNR d'Innovation, Sciences et Développement économique Canada applicables aux appareils radio exempts de licence.

L'exploitation est autorisée aux deux conditions suivantes:

- (1) L'appareil ne doit pas produire de brouillage.
- (2) L'appareil doit accepter tout brouillage radioélectrique subi, même si le brouillage est susceptible d'en compromettre le fonctionnement.

Le fonctionnement de 5150-5250 MHz est limité à une utilisation en intérieur uniquement.

Le présent appareil est conforme. Après examen de ce matériel aux limites d'intensité de champ RF, les utilisateurs peuvent sur l'exposition aux radiofréquences et la conformité and compliance d'acquérir les informations correspondantes. La distance minimale du corps à utiliser le dispositif est de 20 cm.

### 1.3.9 EC DECLARATION OF CONFORMITY

#### Snapmaker EC DECLARATION OF CONFORMITY

##### PRODUCT INFORMATION

Product	3D Printer
Model	Artisan
Function	Snapmaker Modular 3-in-1 3D Printer with 3D Printing, Laser Engraving & Cutting, and CNC Carving functions

##### MANUFACTURER

Shenzhen Snapmaker Technologies Co., Ltd.  
4F & 5F, Building 13, Pingshan First Road,  
Nanshan District, Shenzhen, China  
Post Code: 518000  
(86) 0755-26926117

##### YEAR OF AFFIXING CE MARKING: 2022

We hereby declare under our sole responsibility that the product above is in compliance with the essential requirements of the Machinery Directive (2006/42/EC), EMC Directive (2014/30/EU), Radio Equipment Directive (2014/53/EU), WEEE Directive 2012/19/EU, ROHS Directive (2011/65/EU), Amendment Directives (2015/863/EU) and REACH.

By application of:

STANDARDS	TITLES
EN 55032:2015+A11:2020	EN 55032, Electromagnetic compatibility of multimedia equipment-Emission
EN 55035:2017+A11:2020	EN 55035, Electromagnetic compatibility of multimedia equipment-Immunity
EN IEC 61000-3-2: 2019+A1:2021	EN 61000-3-2, Limits for harmonic current emissions
EN 61000-3-3:2013+A1:2019	EN 61000-3-3, Limits Section 3 (EMC)
EN IEC 62311:2020	RED Article 3.1(a), Health (RED)
BS EN IEC 62311:2020	

ETSI EN 301 489-1 V2.2.3 (2019-11)	
ETSI EN 301 489-3 V2.1.1 (2019-03)	RED Article 3.1(b), EMC (RED)
ETSI EN 301 489-17 V3.2.4 (2020-09)	
ETSI EN 300 328 V2.2.2 (2019-07)	
ETSI EN 301 893 V2.1.1 (2017-05)	RED Article 3.2, Radio (RED)
ETSI EN 300 440 V2.2.1 (2018-07)	
IEC 60825-1:2014 (Edition 3.0)	IEC/EN 60825-1:2014, Safety of laser products-Part 1: Equipment classification and requirements
EN 60825-1:2014	RED Article 3.1(a), Safety (RED)
EN 62368-1:2020+A11:2020	RED Article 3.1(a), Safety (RED)
Council Directive 2006/42/EC, Annex I	Council Directive 2006/42/EC, Annex I Essential health and safety requirements relating to the design and construction of machinery; (MD)
EN 60204-1:2018	EN 60204-1:2018, Safety of machinery - Electrical equipment of machines, Part 1: General requirements (MD)
ISO 13849-1:2015	ISO 13849-1:2015, Safety of machinery - Safety-related parts of control systems - Part 1: General principles for design (MD)
EN ISO 12100:2010	EN ISO 12100:2010, Safety of machinery - General principles for design - Risk assessment and risk reduction (MD)
Directive 2011/65/EU	A RoHS Directive 2011/65/EU and amendment directives (EU) 2015/863 on Lead, Cadmium, Mercury, Hexavalent Chromium, PBBs & PBDEs, Phthalates(DBP, BBP, DEHP, DIBP) content (RoHS)
Directive 2012/19/EU	WEEE Directive 2012/19/EU (WEEE)
(EC) No 1907/2006	European Chemicals Agency (ECHA) regarding Regulation (EC) No 1907/2006 and its amendment directives concerning the REACH. (REACH)

The technical documentation is kept at the Manufacturer's address.





*Chen Xuedong*

Shenzhen Snapmaker Technologies Co., Ltd.  
CHEN XUEDONG / CEO  
Date of issue: 11/30/2022  
Place of issue: SHENZHEN, CHINA

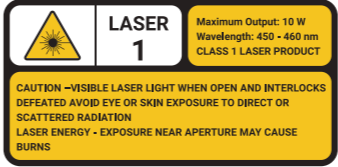

# 1.4 Safety Labels on Your Snapmaker

Label	Warning	Location
	Avoid contact with hot surfaces.	On the Dual Extrusion Module, glass build plate, and heated bed
	Take care to avoid injury from sharp objects (e.g., CNC bits).	On the 200W CNC Module
	Take care to avoid crushing hands.	On the Dual Extrusion Module
	Beware of potential hazards.	On the glass build plate and heated bed
	Avoid touching the object when printing or when the object has not cooled down after a print.	On the glass build plate and heated bed
	Take care when handling fragile objects.	On the glass build plate
	Do not print directly on this surface.	On the heated bed

Label	Warning	Location
	Do not plug or unplug the cable when the machine is powered on.	On the heated bed cable
	Laser radiation is emitted from this aperture. Do not touch the aperture, and avoid eye and skin exposure to direct or scattered radiation.	On the 10W Laser Module
	Class 4 laser product. Avoid eye and skin exposure to direct or scattered radiation.	On the 10W Laser Module
	Class 1 laser product. Avoid eye and skin exposure to direct or scattered radiation when the interlocks are defeated.	On the Enclosure Door
	Do not place objects that weigh more than 7 kg on this surface.	On the top panel of the Enclosure

\* The photographs in this guide take the safety label required in the EU region as an example.

\* The same label on different locations may vary in color or texture.



# 1.5 Specifications

## Machine & Enclosure

Dimensions (W × D × H)	Machine: 580 mm × 620 mm × 634 mm Machine & Enclosure: 849 mm × 995 mm × 705 mm Minimum Footprint: 1035 mm × 1690 mm × 705 mm
------------------------	---

Net Weight	52.9 kg
------------	---------

Frame Material	Machine & Enclosure Profile: Aluminum alloy Enclosure Panel: Acrylic sheet
----------------	---

Supported Software	Snapmaker Luban and third-party software
--------------------	--

Data Transmission	Wi-Fi, USB cable, USB flash drive
-------------------	-----------------------------------

## Integrated Controller

Dimensions (W × D × H)	189 mm × 300 mm × 191 mm
------------------------	--------------------------

Touchscreen	Size: 7 in. Resolution: 1280 × 800 pixels
-------------	--

Rated Voltage	AC 100 V-240 V, 50 Hz/60 Hz
---------------	-----------------------------

Rated Current	8.3 A Max.
---------------	------------

Rated Power	750 W
-------------	-------

Memory	1GB RAM, 8GB eMMC
--------	-------------------

OS	Android 10.0
----	--------------

Wi-Fi	Protocol: 802.11a/b/g/n20/n40 Frequency Range: 2412-2462 MHz (USA & Canada), 2412-2472 MHz (EU) 5150–5250 MHz, 5725–5850 MHz (USA, Canada & EU) Transmitter Power (EIRP): 2.4 GHz: < 20.51 dBm (USA & Canada), < 16.94 dBm (EU) 5.2 GHz: < 17.21 dBm (USA & Canada), < 16.06 dBm (EU) 5.8 GHz: < 15.09 dBm (USA & Canada), < 12.92 dBm (EU)
-------	---

Bluetooth	Protocol: BT 2.1 + EDR/3.0 Frequency Range: 2402 MHz–2480 MHz Transmitter Power (EIRP): < 3.68 dBm (USA & Canada), < 2.28 dBm (EU)
-----------	--

## Linear Module

Motor Driver Chip	TMC2209
-------------------	---------

Repeatability	± 0.05 mm
---------------	-----------

Lead	X axis: 40 mm Y axis: 40 mm Z axis: 8 mm
------	--

Stroke	X axis: 400 mm Y axis: 400 mm Z axis: 400 mm
--------	--

## 3D Printing

Build Volume (X × Y × Z)	Dual Nozzle: 350 mm × 400 mm × 400 mm Left Nozzle: 375 mm × 400 mm × 400 mm Right Nozzle: 400 mm × 400 mm × 400 mm
--------------------------	---

Dimensional Accuracy <sup>1</sup>	± 0.1 mm
-----------------------------------	----------

Nozzle Diameter	0.4 mm (included) 0.2 mm, 0.6 mm, 0.8 mm (sold separately)
-----------------	---

Nozzle Material	Brass (included) Hardened steel (sold separately)
-----------------	--

Max. Nozzle Temp.	300°C
-------------------	-------

Max. Printing Speed	180 mm/s
---------------------	----------

Build Plate	PEI/Glass Double-sided Plate
-------------	------------------------------

Inner Zone	260 mm × 260 mm
------------	-----------------

Max. Heated Bed Temp.	Inner Zone Heated Only: 110°C Whole Bed Heated: 80°C
-----------------------	---

Supported Materials <sup>2</sup>	PLA, Breakaway PLA, TPU90, TPU95, High Flow TPU95, TPU-Foam, PVA, ABS, PETG, ASA, HIPS, CoPA, PA12-CF, PA6-CF, PA6-GF
----------------------------------	---

Supported Material Diameter	1.75 mm
-----------------------------	---------

Operating Sound	≤ 55 dBA (distance: 1 m)
-----------------	--------------------------

## Laser Engraving & Cutting

Work Area (X × Y)	400 mm × 400 mm
-------------------	-----------------

Power	10 W
-------	------

Laser Type	450 nm–460 nm Semi-conductor
------------	---------------------------------

Laser Classification (within Enclosure)	Class 1
---	---------

Max. Engraving Speed	100 mm/s
----------------------	----------

Max. Cutting Depth (Paulownia)	8 mm
--------------------------------	------

Operating Temp.	0°C–35°C
-----------------	----------

Laser Spot Dimensions	0.05 mm × 0.2 mm
-----------------------	------------------

Supported Materials for Engraving	Basswood, Paulownia, Pinewood, Plywood, Beech, Walnut, Bamboo, MDF, Painted Metal, Copper Clad Laminate, Tinplate, Stainless Steel, Anodized Aluminum, Dark Glass, Slate, Ceramics, Jade, Marble, Shale, Leather, Fabric, Canvas, Corrugated Paper, Cardboard, Plastic, Dark Acrylic (Blue excluded)
-----------------------------------	--

Supported Materials for Cutting	Basswood, Paulownia, Pinewood, Plywood, Beech, Walnut, Bamboo, MDF, Leather, Fabric, Canvas, Corrugated Paper, Cardboard, Plastic, Dark Acrylic (Blue excluded)
---------------------------------	---

Bluetooth (10W Laser Module)	Protocol: BT 2.1 + EDR/3.0 Frequency Range: 2402 MHz–2480 MHz Transmitter Power (EIRP): < 11.35 dBm (USA & Canada), < 9.23 dBm (EU)
------------------------------	---

[1] The test result was obtained by printing a 100 mm × 100 mm × 100 mm cube with PLA filament and the 0.4 mm nozzle. Dimensional accuracy may vary depending on the testing conditions and product iteration and is for reference only.

[2] The hardened steel nozzle should be used when printing with CoPA, PA12-CF, PA6-CF and PA6-GF.

[3] The data is obtained by cutting Beech with the 3.175 mm flat end mill (double-flute) and Acrylic with the 3.175 mm flat end mill (single-flute). The cutting speed might vary depending on the CNC bits and materials used.

\* Note: The specifications above are subject to change as we improve the product.

## CNC Carving & Cutting

Work Area (X × Y)	400 mm × 400 mm
-------------------	-----------------

Power	200 W
-------	-------

Max. Spindle Speed	18,000 RPM
--------------------	------------

Max. Work Speed <sup>3</sup>	Beech: 50 mm/s Acrylic: 33 mm/s
------------------------------	------------------------------------

Max. Stepdown	Beech: 2 mm Acrylic: 1 mm
---------------	------------------------------

Shank Diameter	0.5 mm–6.35 mm
----------------	----------------

Supported Materials	Hardwood (Beech, Walnut), Softwood, HDF, MDF, Plywood, Jade, Carbon Fiber, Acrylic, Epoxy Tooling Board, PCB
---------------------	--

## Snapmaker Luban

Supported OS	Windows, macOS, Linux
--------------	-----------------------

Supported File Formats	3D Printing: .stl, .obj Laser Engraving and Cutting: .stl, .svg, .png, .jpg, .jpeg, .bmp, .dxf CNC Carving and Cutting: .stl, .svg, .png, .jpg, .jpeg, .bmp, .dxf
------------------------	---

Generated File Formats	3D Printing: .gcode Laser Engraving and Cutting: .nc CNC Carving and Cutting: .cnc
------------------------	--

# 1.6 Parts List

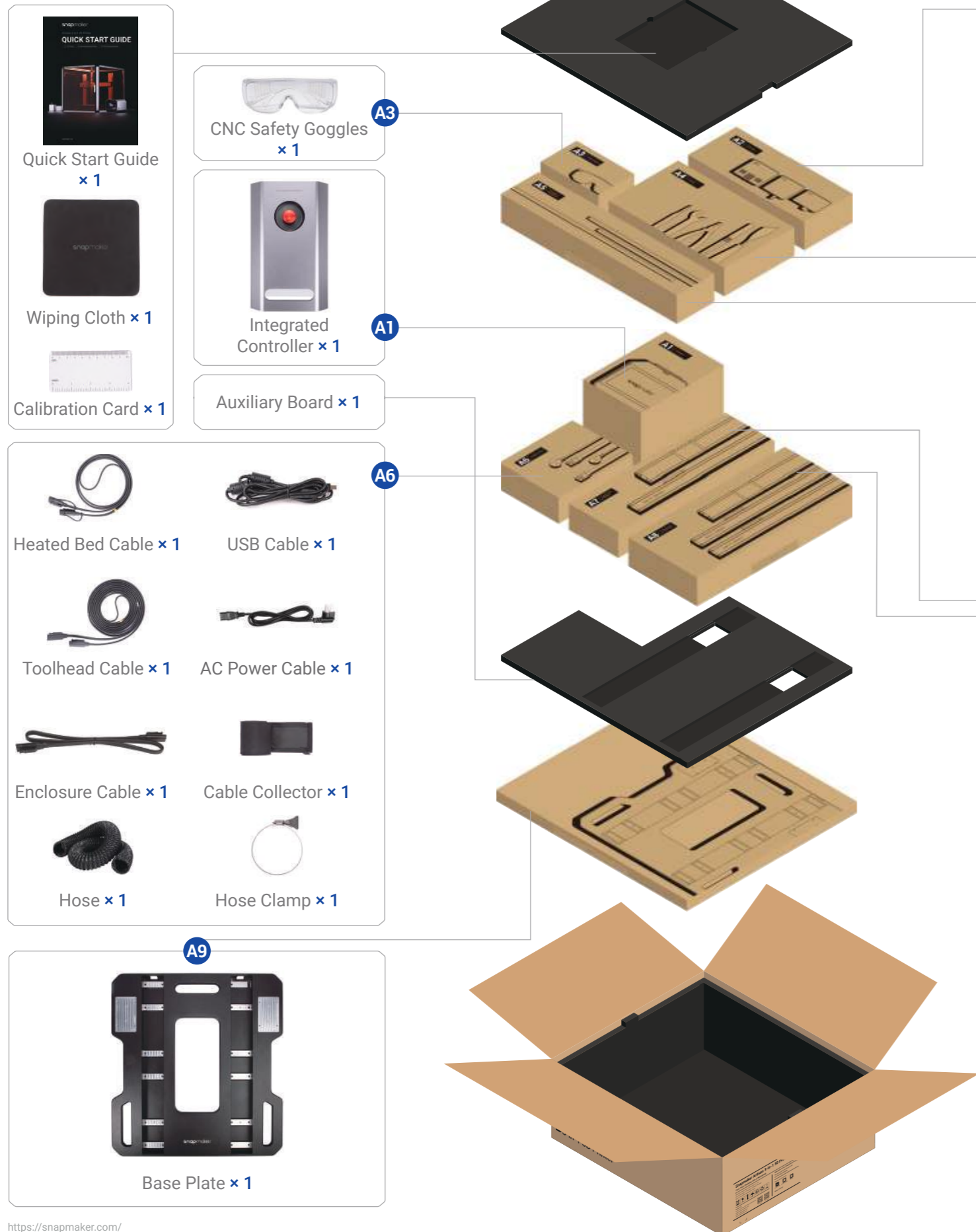

- Quick Start Guide × 1
- Wiping Cloth × 1
- Calibration Card × 1

- CNC Safety Goggles × 1

- Integrated Controller × 1

- Auxiliary Board × 1

- Heated Bed Cable × 1
- USB Cable × 1
- Toolhead Cable × 1
- AC Power Cable × 1
- Enclosure Cable × 1
- Cable Collector × 1
- Hose × 1
- Hose Clamp × 1

- Base Plate × 1

- A2 Dual Extrusion Module × 1
- 10W Laser Module × 1
- 200W CNC Module × 1
- Toolhead Bracket × 1

- A4 Calibration Target × 1
- ER11 Collet & ER11 Nut × 1
- Star Knob × 4
- H3.0/H2.5/H2.0/H1.5 Hex Key × 4
- 17mm Open-end Wrench × 1
- 14mm Open-end Wrench × 1
- Palette Knife × 1
- Diagonal Pliers × 1
- Fixture Accessory × 4
- Arched Fixture × 4
- USB Flash Drive × 1
- Laser Lens Protector × 1
- Straight Groove V-bit (double-flute) × 1
- Flat End Mill (single-flute) × 1
- Flat End Mill (double-flute) × 1
- Tweezers × 1
- Wire Brush × 1
- M4 × 60 Screw × 4

- A8 X-axis Linear Module × 1
- Y-axis Linear Module × 2
- A7 Z-axis Linear Module × 2

- A5 M5 × 12 Screw × 60 (for machine)
- M3 × 20 Screw × 3
- Cable Pass-through Fixture × 1
- Cable Clip × 4
- M5 × 16 Flat Head Screw × 5
- M4 × 12 Flat Head Screw × 7
- Sealing Strip × 1
- Sealing Plug × 4
- M5 × 16 Low Head Cap Screw × 18 (for machine)
- M4 × 20 Screw × 7
- M4 × 35 Screw × 5
- Left Filament Holder Base × 1
- Filament Tube Clip × 2
- M5 × 12 Screw × 12 (for Enclosure)
- M4 Wing Nut × 5
- Filament Holder Tube × 2
- Filament Tube Holder × 2
- M5 × 16 Low Head Cap Screw × 12 (for Enclosure)
- L Bracket × 1
- M4 × 12 Low Head Cap Screw × 2
- M5 × 30 Screw × 20
- Cotton Swab × 5
- Laser Material Fixture × 4
- M6 × 16 Screw × 8
- Base Fixture (upper & lower) × 2

Black PLA × 1    White Breakaway PLA × 1

Basswood Sheet × 1    HDF Sheet × 1

Cord Collecting Strip × 1    Filament Tube × 2

B2

X-axis Connector × 2    Z-axis Holder × 2

B3

3D Printing Platform × 1    Support Platform × 1

CNC Carving and Cutting Platform × 1    Laser Engraving and Cutting Platform × 1

B4

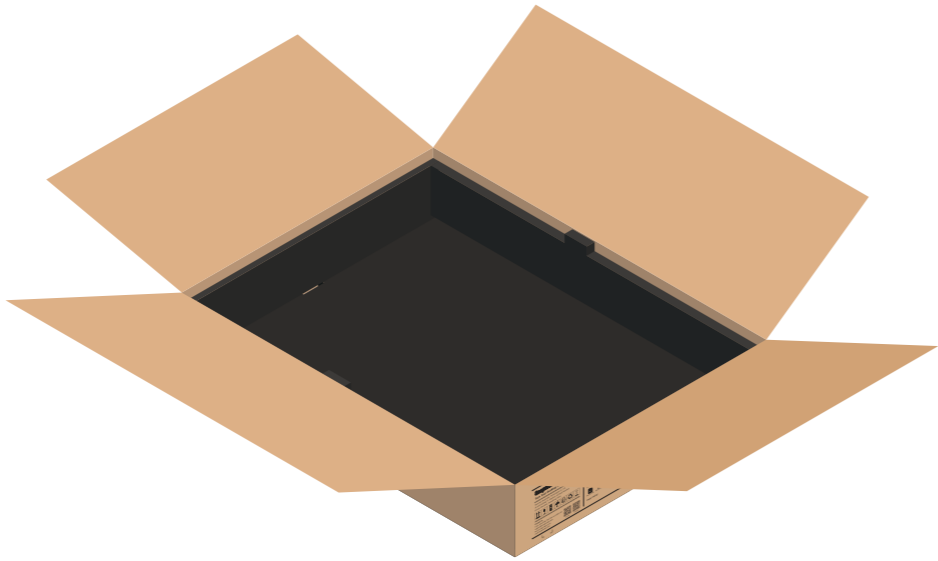
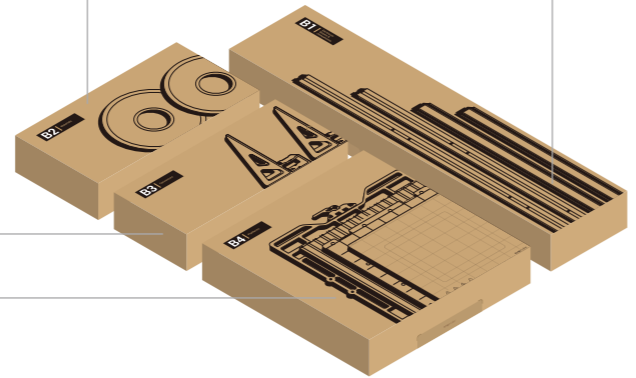
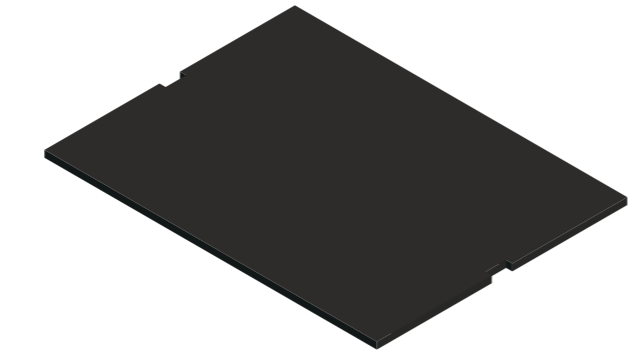

Column-1 (with hinge) × 1    Short Beam (front) × 1

Column-2 (with hall switch) × 1    Short Beam (rear) × 1

Column-3 (with Enclosure converter) × 1    Long Beam × 2

Column-4 × 1

Door Handle × 1    Profile Connector × 4    Hose Connector × 1    Exhaust Fan × 1





B1

Top Panel Kit × 1    Door Panel × 1

Side Panel × 2    Back Panel × 1

B5

## 1.7 Used Symbols

	<b>WARNING</b>	Failure to observe this instruction may lead to damage to the product or personal injury.
	<b>CAUTION</b>	Details you should pay attention to when assembling and using the printer.
	<b>TIPS</b>	Provides convenient operations or extra choices.
	<b>EXPLANATION</b>	Provides supplementary information for a better understanding of the instruction.
	<b>ORIENTATION</b>	Make sure the pointed part is facing the right way when you see this symbol.

## 1.8 Tips & Notes

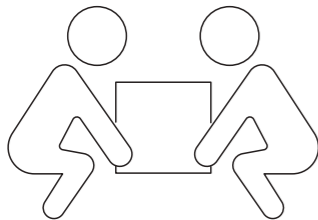
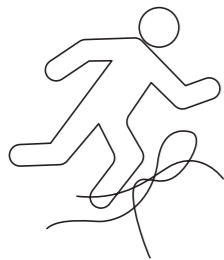
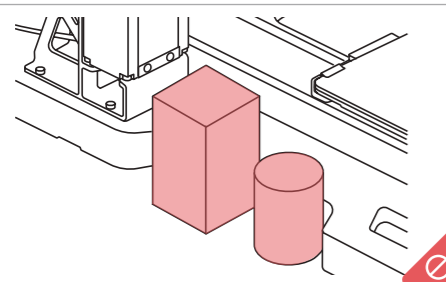
	At least two people are required to assemble and lift the machine and the Enclosure.
	Collect and sort the cables in time lest anyone should trip over them.
	Do NOT place any object near the left or the right side of the base plate to avoid interfering with the movement of the Linear Modules and the work platforms.

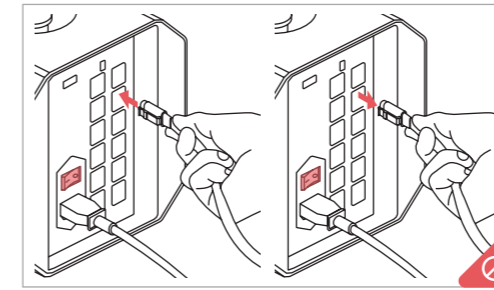

Do NOT plug or unplug any cables when the machine is powered on.

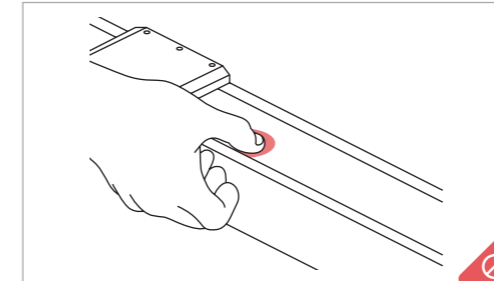

Do NOT press the steel strip.

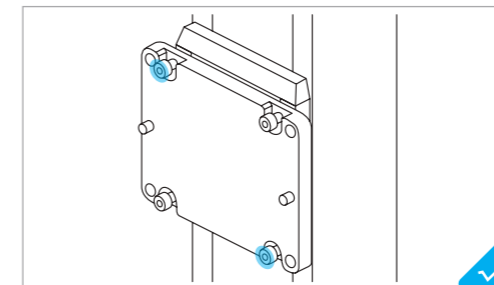

To install multiple screws in one step:

1. Pre-tighten the screws at the outermost corner;
2. Pre-tighten the remaining screws;
3. Tighten all the screws in the pre-tightening order.

\* Pre-tighten: To screw the screw into the hole, yet not fully tighten it.

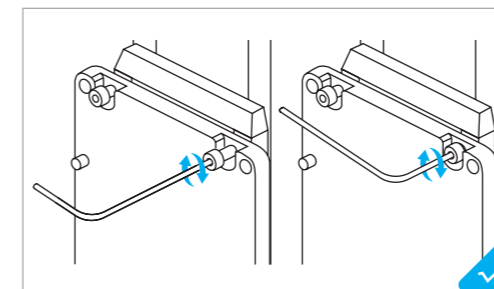

To install screws with the provided hex key:

1. Screw the screw into the hole with the long handle;
2. Tighten the screw with the short handle.

## 1.9 Common Operations

### 1.9.1 Power Loss Recovery & Filament Runout Recovery

Your Artisan supports Power Loss Recovery and Filament Runout Recovery, so you don't need to worry about unexpected disruption anymore!

In case of power loss during a job, you can choose to resume or cancel the job on the Touchscreen after the machine is powered on again.

 The cooling down of the heated bed before the machine is powered on again will weaken the adhesion between the print and the platform, which might result in failure of recovery.

When the filament runs out, you can tap **Load Filament** on the pop-up window and follow the on-screen instructions to load the new filament and resume printing.

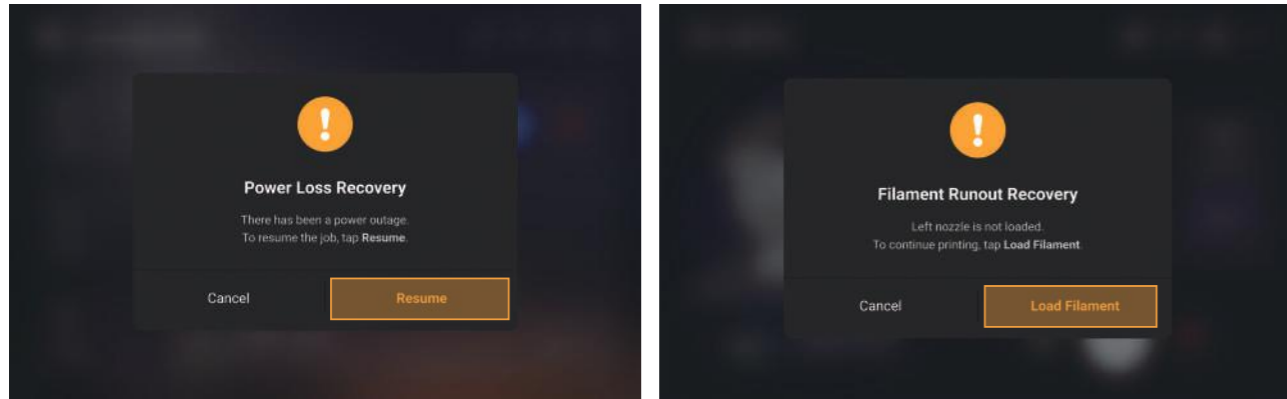

## 1.9.2 Module Replacement

To replace modules, remove or add addons, tap  > **Replace Module** and follow the on-screen instructions to complete the operations without turning off the power switch.

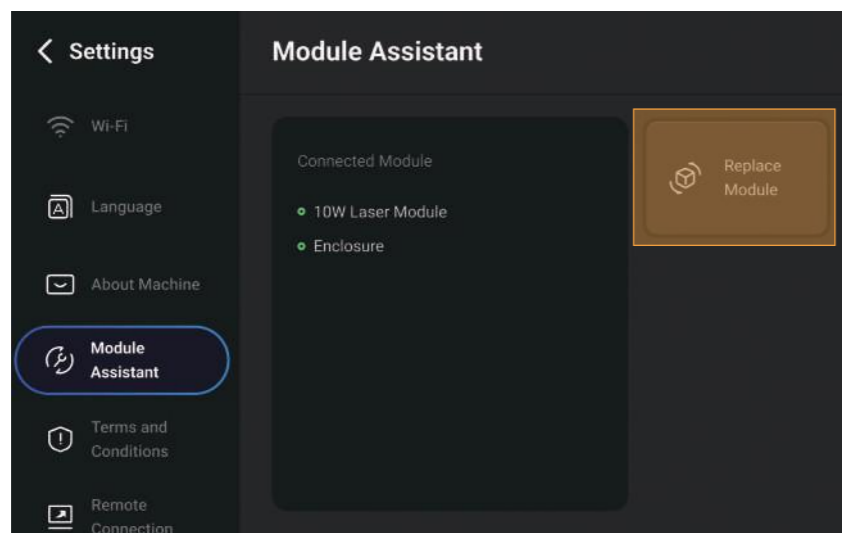
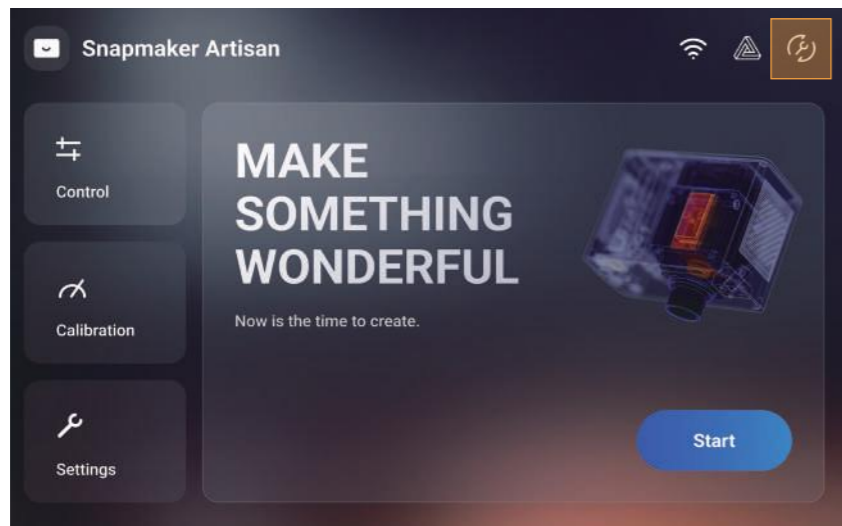

You can also tap **Settings > Module Assistant > Replace Module**.



You can also turn off the power switch first and then replace modules, remove or add addons.

## 1.9.3 Firmware Update

You can update the firmware via Wi-Fi or a USB flash drive. When a new firmware version is available, the machine will remind you to update when connected to a Wi-Fi network. We recommend that you always update the firmware to the latest version.

### Update via Wi-Fi:

1. Connect the machine to a Wi-Fi network;
2. On the Home Screen, tap **Settings > Firmware Update**;
3. If there is a new firmware version, click **Download**;
4. After the firmware download is finished, click **Update**.

### Update via USB Flash Drive:

1. On the navigation bar of the Snapmaker official website, click **Support > Product Support > Snapmaker Artisan > Firmware**. Then, download the latest firmware version and save it to your USB flash drive.
2. Insert the USB flash drive into the Integrated Controller;
3. On the Home Screen, tap **Settings > Firmware Update > Local Update**;
4. Select the newly downloaded firmware version and tap **Update** in the pop-up window.

## 1.10 About This Guide

This Quick Start Guide is intended to guide you through the assembly of Snapmaker Artisan and the first-time operation of 3D printing, Laser engraving and cutting, and CNC carving and cutting with concise instructions and graphics. The workflows of the three functions described in this guide are what we consider to be the most convenient ones for you to get started quickly. For other workflows and more information about Snapmaker Artisan, refer to our online User Manual: On the navigation bar of the Snapmaker official website, click **Support > Product Support > Snapmaker Artisan > User Manual**.

# Machine Assembly

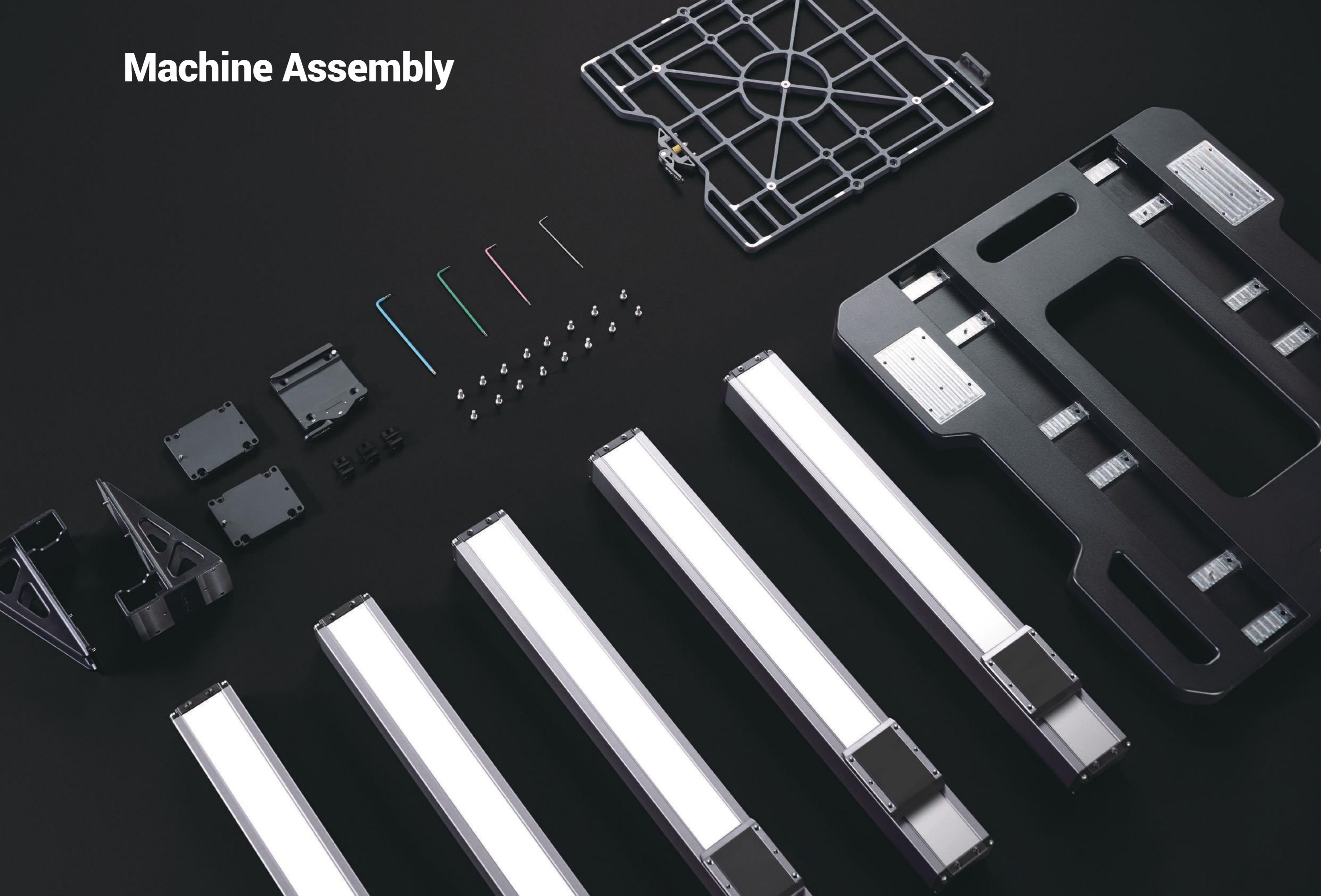

# 01<sub>/22</sub>

Prepare a space of at least 1035 mm (W) × 1690 mm (D) × 705 mm (H) for assembly and use.

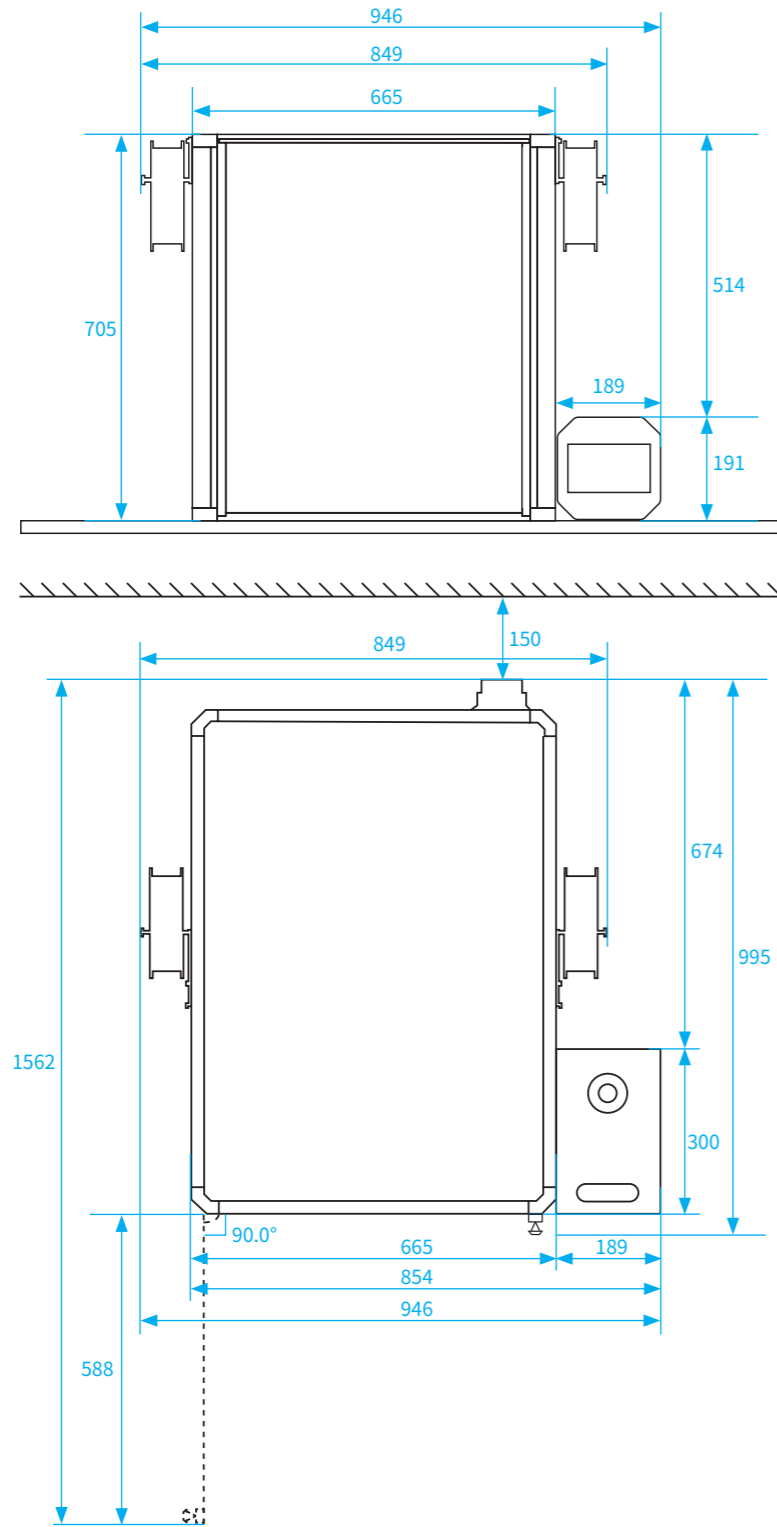

Ensure that the load capacity of the plane where you perform the assembly is greater than 65 kg. We recommend assembling the machine where you will use it later and where it is convenient for gas exhaust.

# 02<sub>/22</sub>

Identify the two Linear Modules labeled with "Y" on the cable connector. They will be the Y axes.



Y-axis Linear Module × 2 **A8**



All the Linear Modules must be installed in their intended position. Incorrect installation or mixed use of the Linear Modules will result in malfunction of or damage to the machine.

# 03 /22

Put the Y axes into the slots of the auxiliary board.

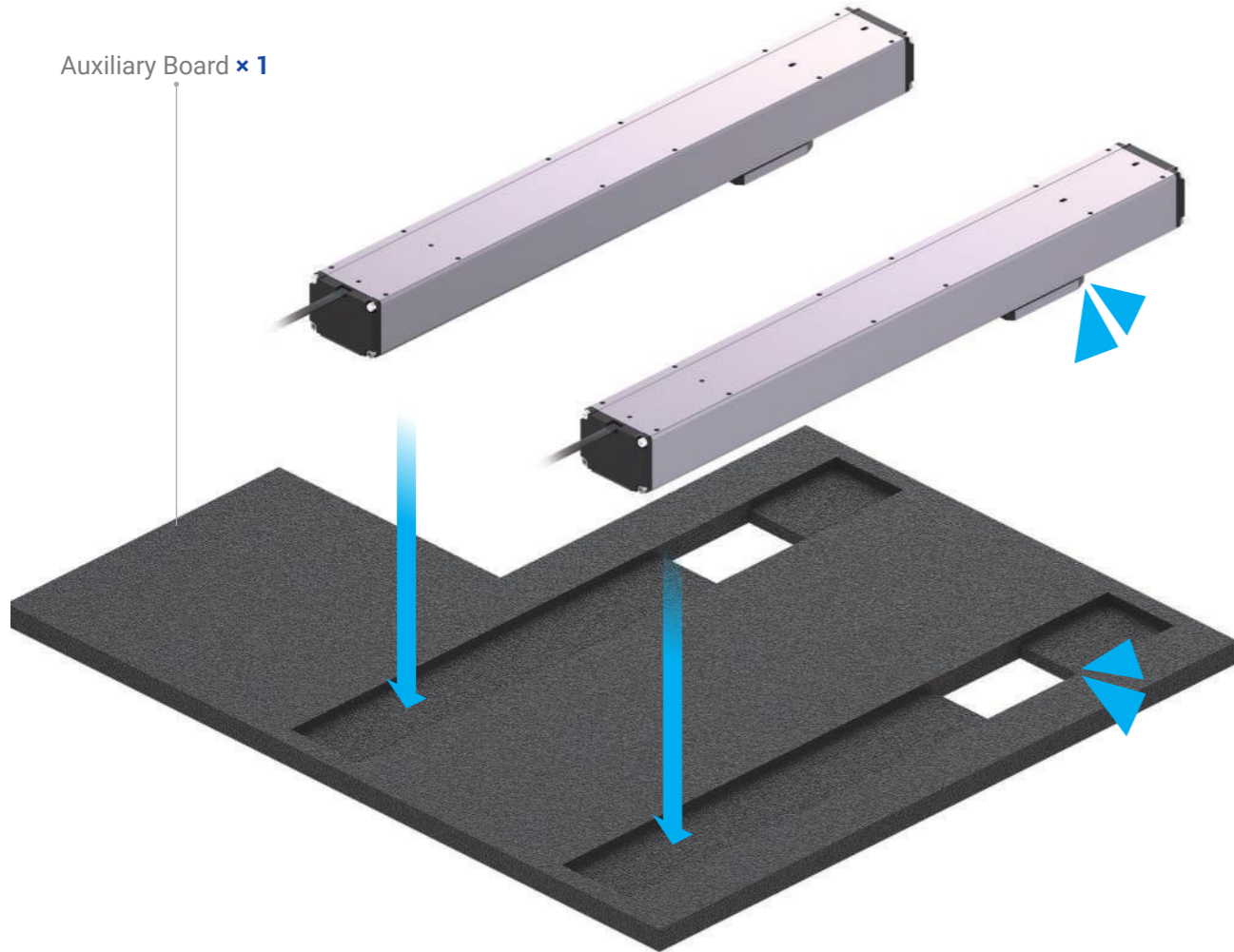

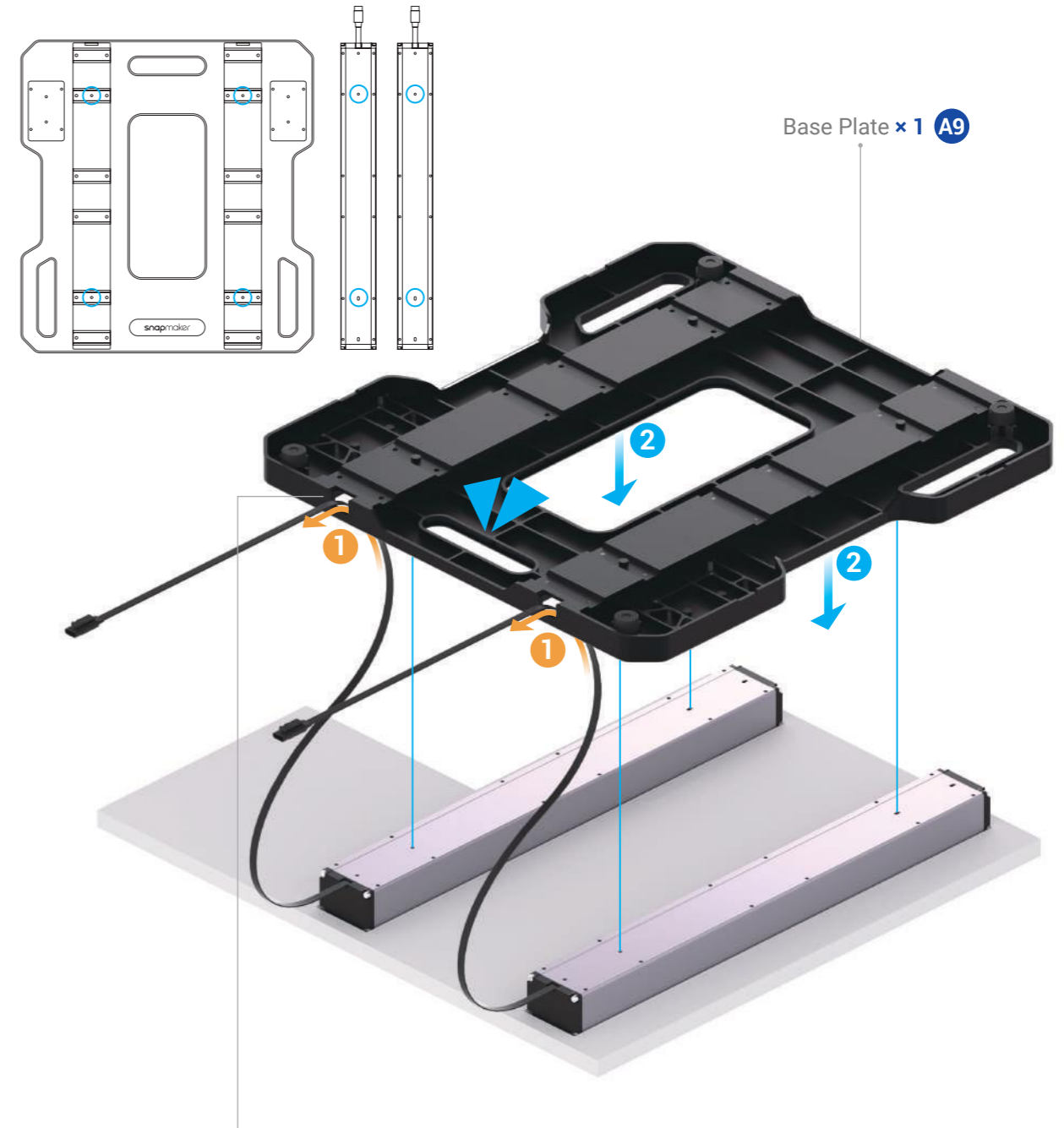

# 04 /22

Thread the Y-axis cables through the cable holes of the base plate, and insert the dowels of the base plate into the dowel holes of the Y axes.



 Straighten the Y-axis cable to avoid its twisting between the Y axis and the base plate.



 Make sure to fully insert the dowels into the dowel holes.



 The dowel can lock the relative position of two parts, avoiding possible misalignment during the assembly.



05<sub>/22</sub>

Attach the Y axes to the base plate.

M5 × 12 Screw × 24

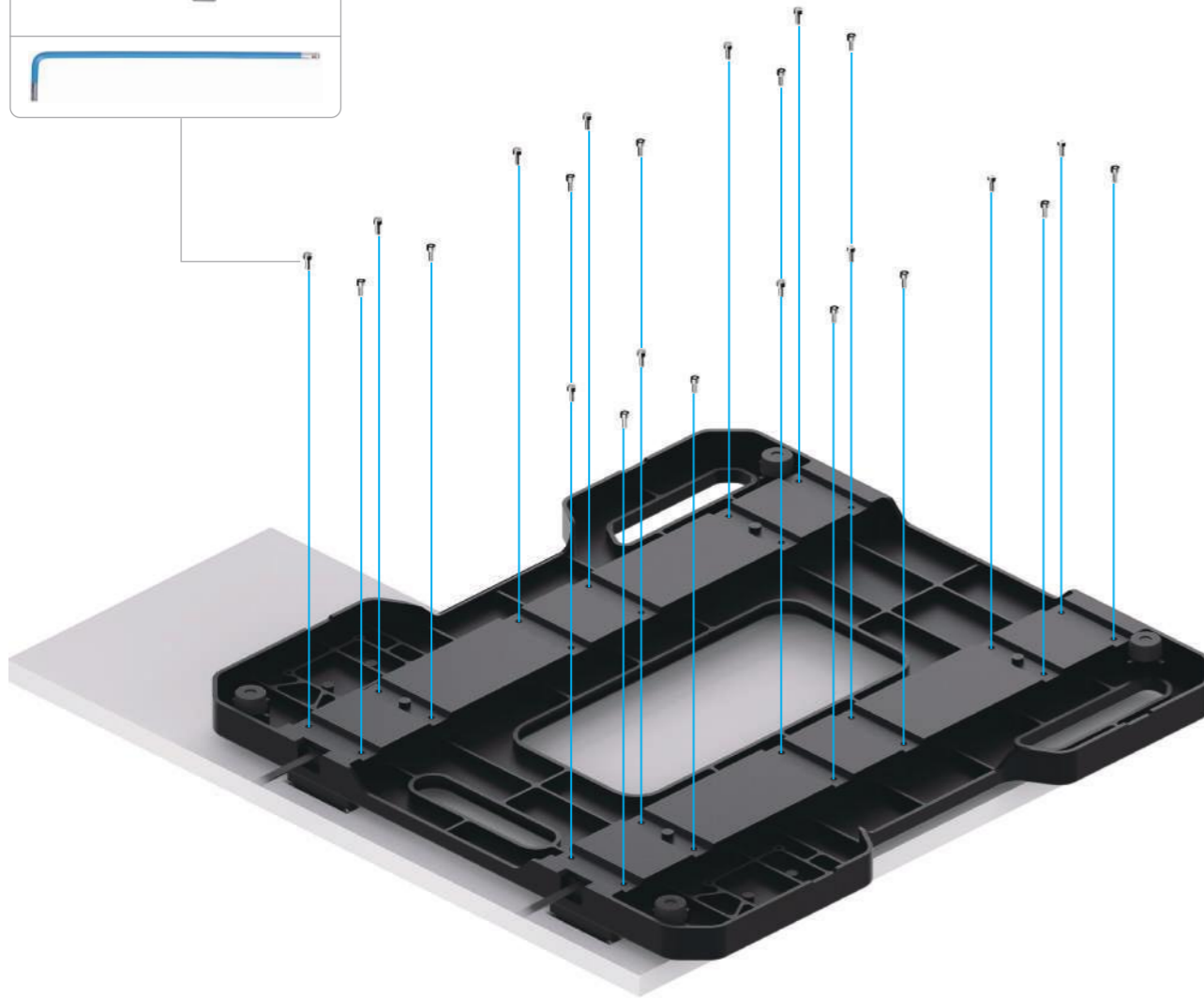

It is recommended to pre-tighten the screws at the outermost corners first, then pre-tighten the remaining screws, and finally tighten all the screws in the pre-tightening order.



If you find it difficult to install the screws even following the tip above, check if the dowels of the base plate are correctly inserted into the dowel holes of the Y axes.

06<sub>/22</sub>

Flip the base plate to the front side by holding the handle on its edge, and remove the auxiliary board.



Flip the base plate slowly and carefully.



After the operation, try to move the Y axes to check if they have been firmly attached to the base plate.

# 07 /22

Identify the two Linear Modules labeled with "Z" on the cable connector. They will be the Z axes.



All the Linear Modules must be installed in their intended position. Incorrect installation or mixed use of the Linear Modules will result in malfunction of or damage to the machine.



It does not matter if the slider position of your Z axis differs from the illustration until Step 13.

# 08 /22

Insert the dowels of the X-axis connectors into the dowel holes of the Z-axis sliders.

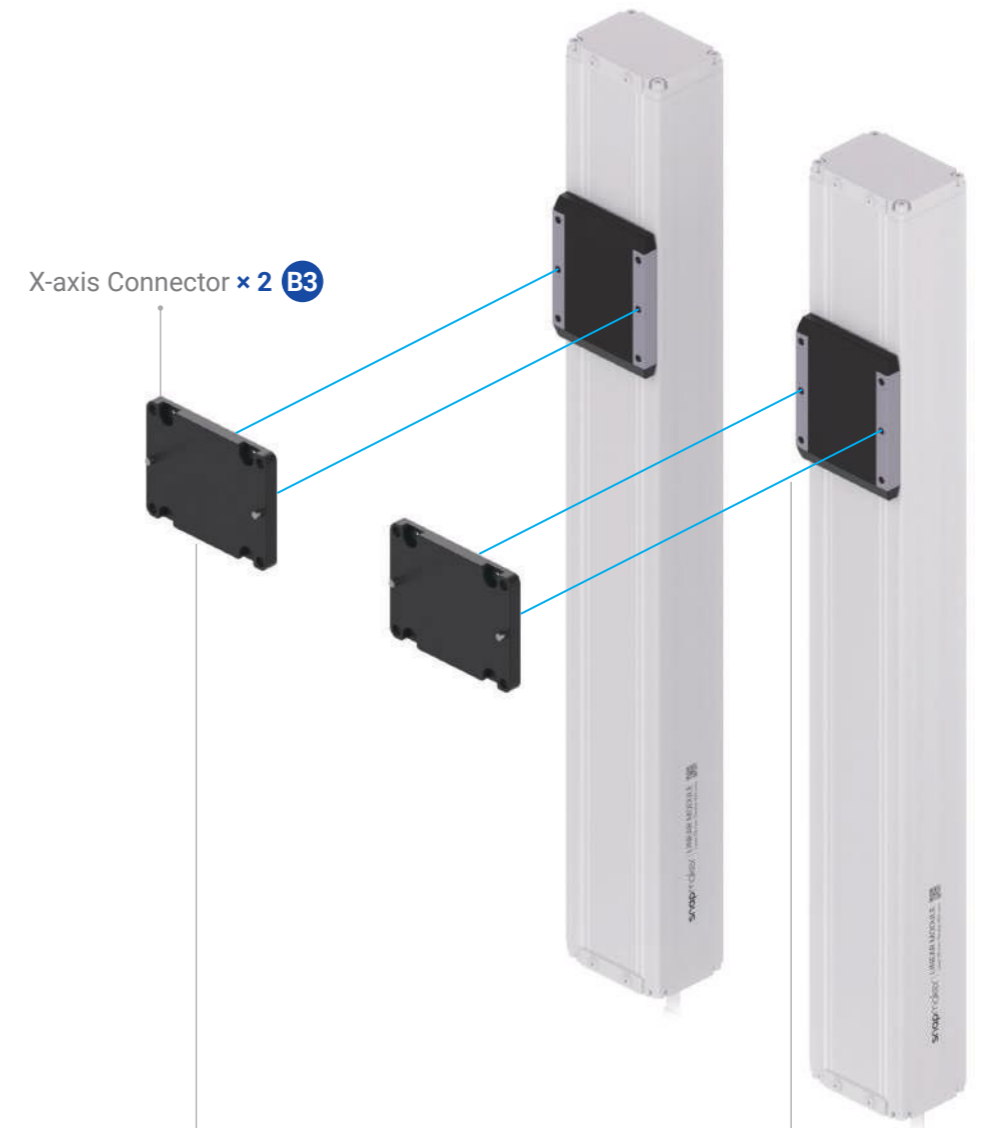

Make sure to fully insert the dowels into the dowel holes.

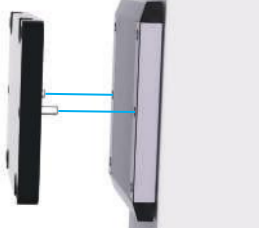

09 /22

Attach the X-axis connectors to the Z-axis sliders.

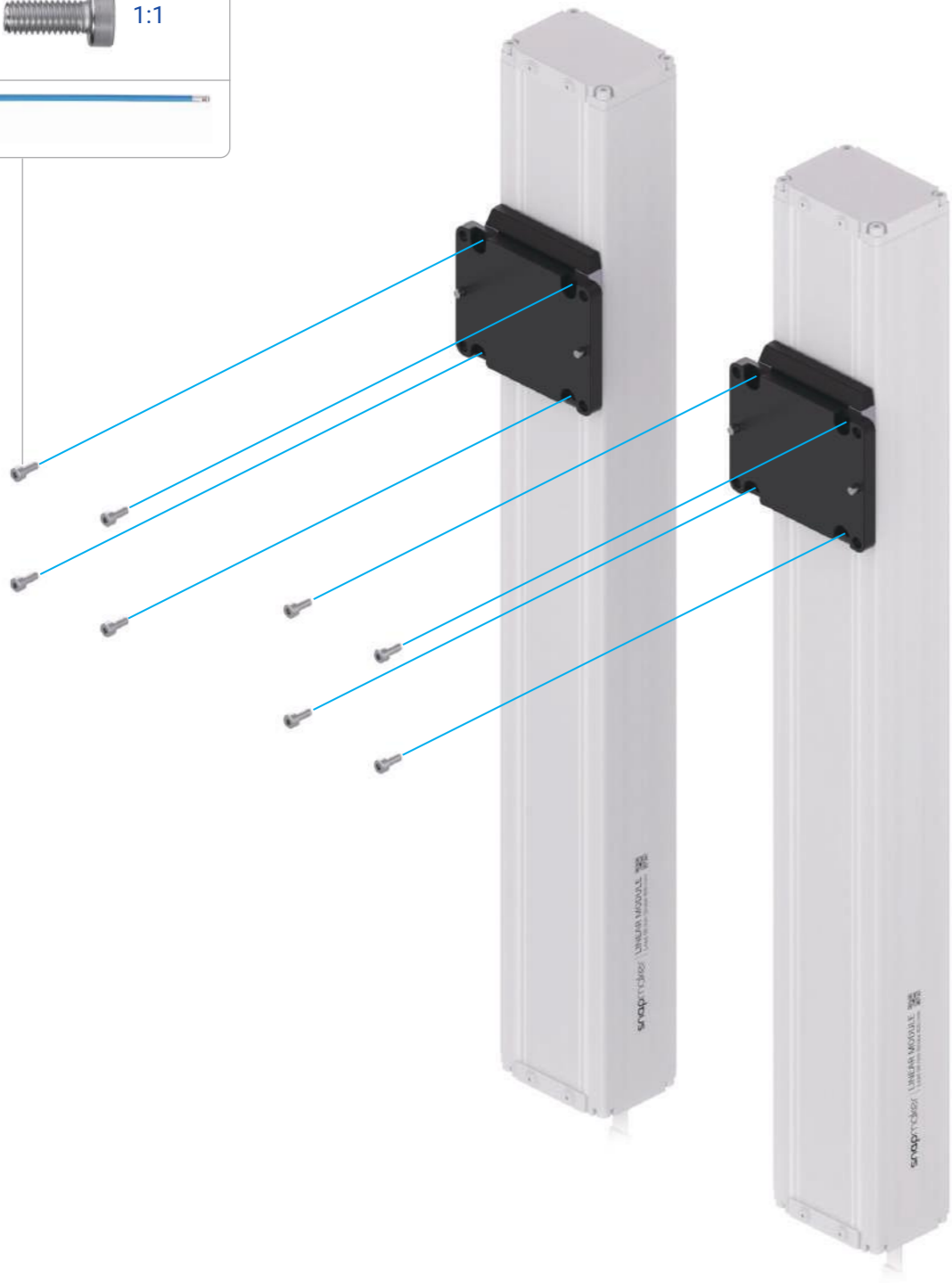
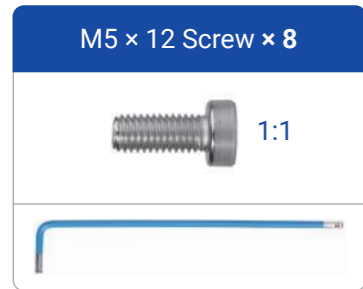

10 /22

Thread the Z-axis cables through the cable holes, and then insert the dowels of the Z-axis holders into the dowel holes of the Z axes.

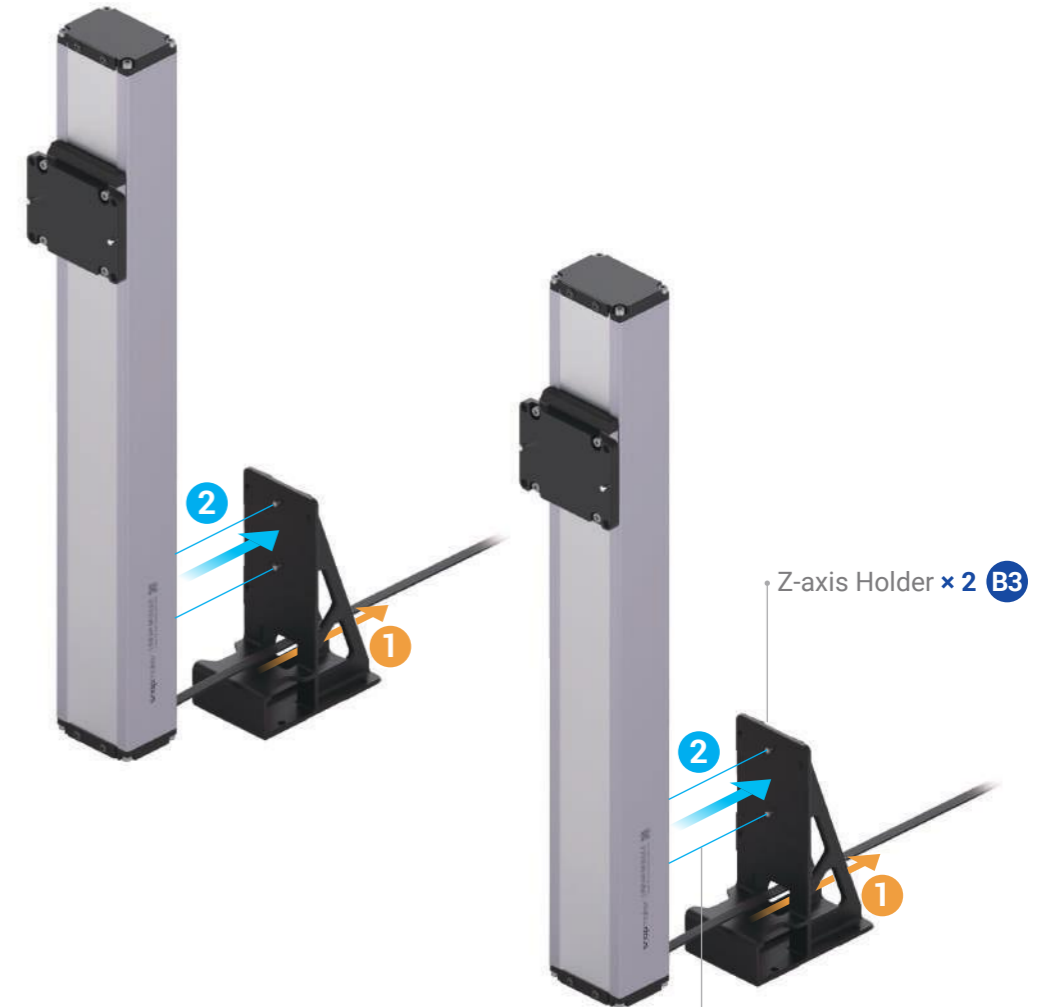

Make sure to fully insert the dowels into the dowel holes.

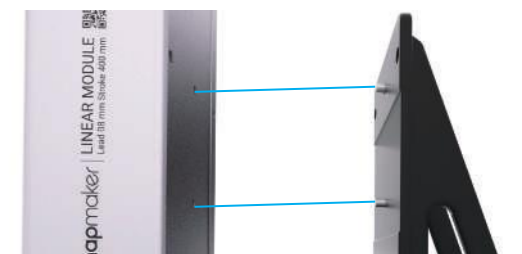

There is an intended clearance of about 2 mm between the bottom of the Z axis and the Z-axis holder.

**11** /22 Attach the Z axes to the Z-axis holders.

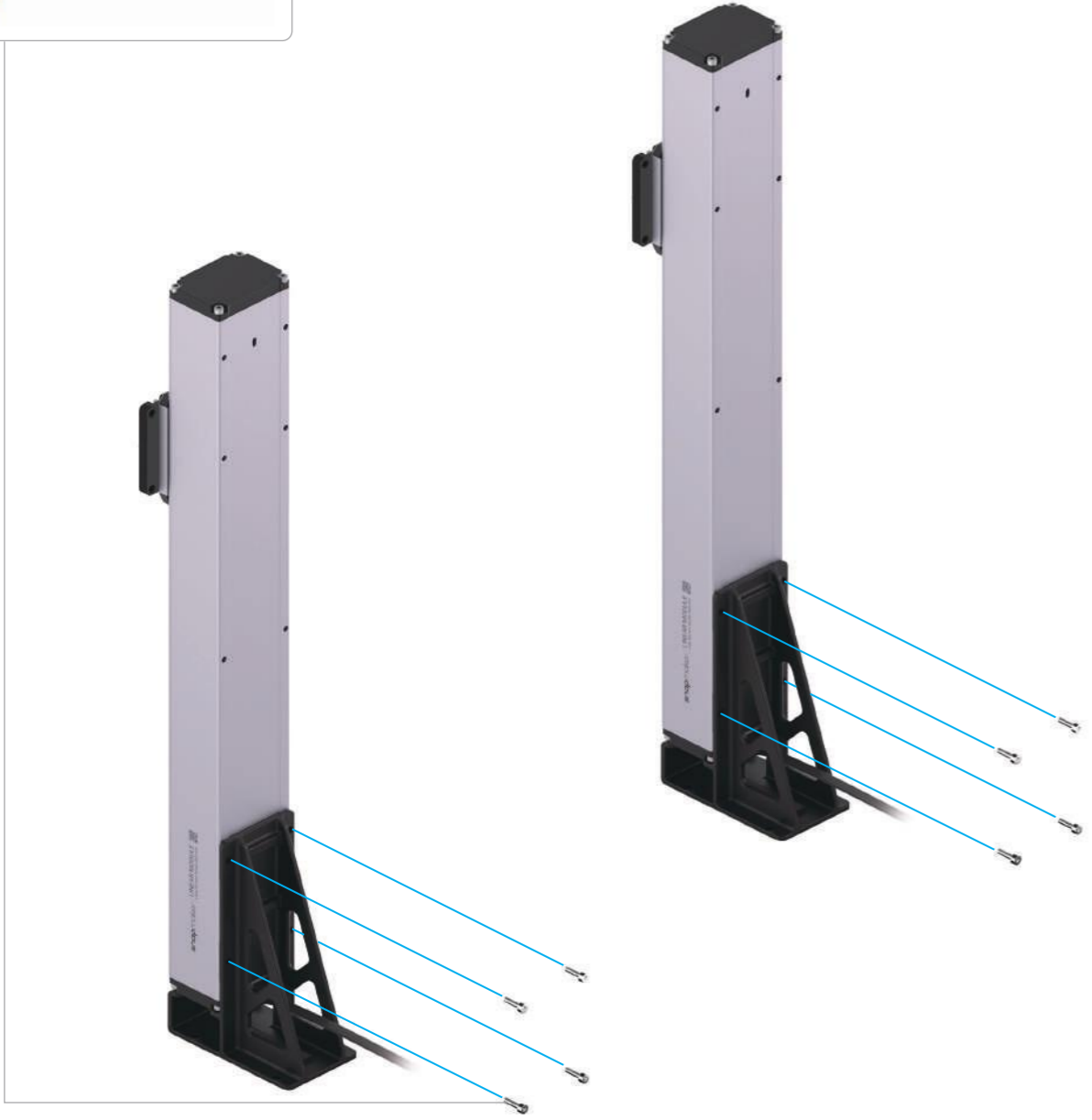
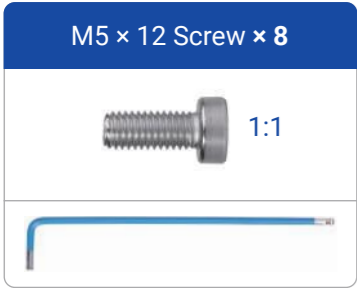

**12** /22 Insert the dowels of the base plate into the dowel holes of the Z-axis holders, and attach the Z-axis holders to the base plate with screws.

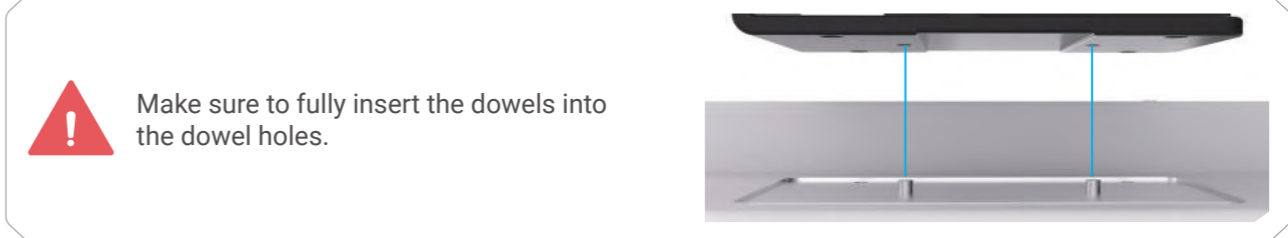
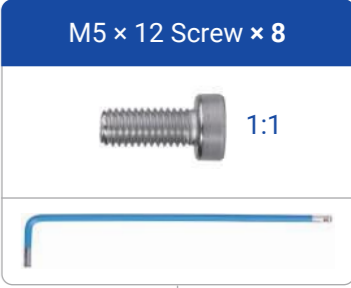

**!** Make sure to fully insert the dowels into the dowel holes.

13<sub>/22</sub>

Move the Z-axis sliders downward to their farthest ends.

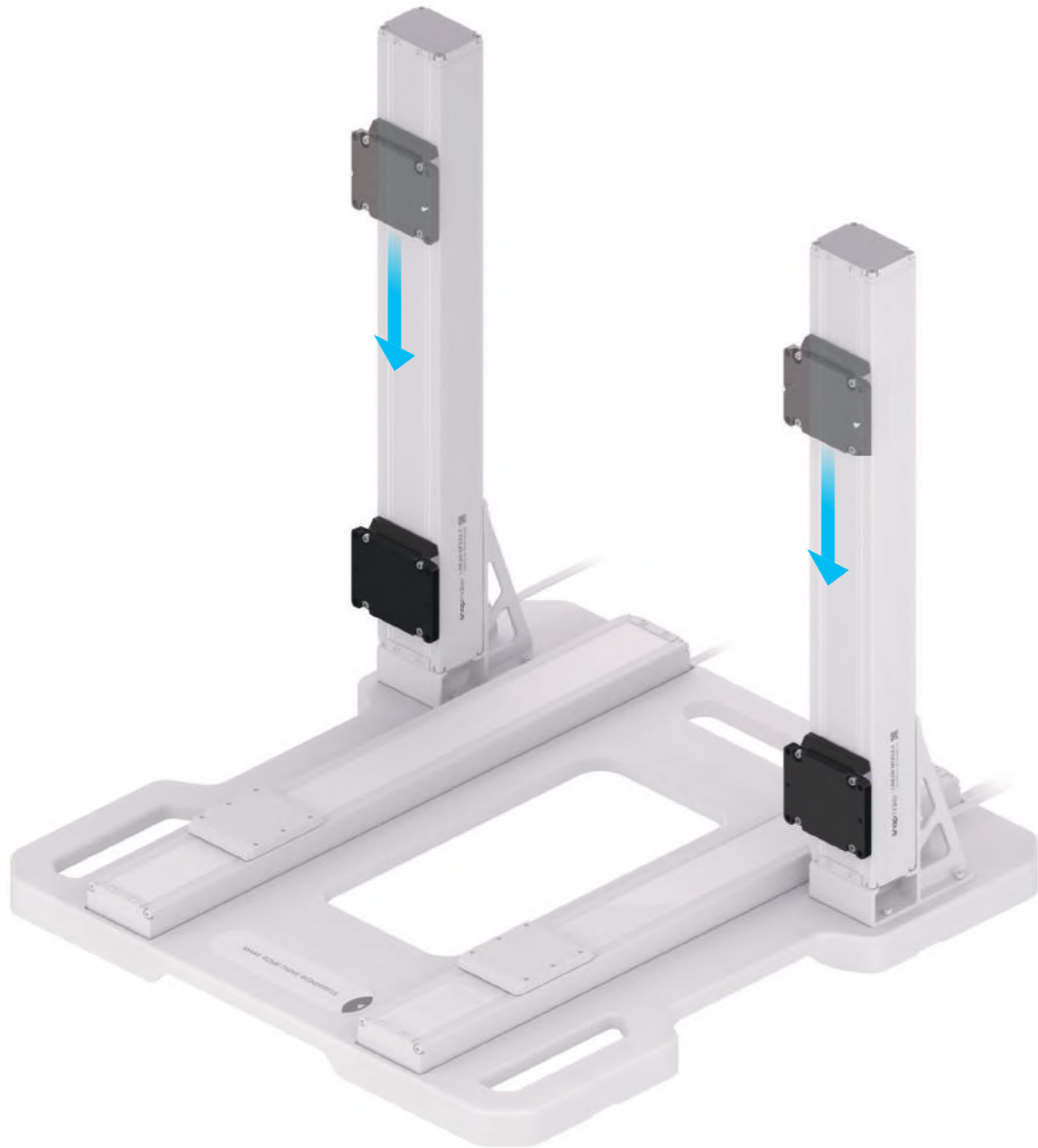

This step ensures the horizontal alignment of the two Z-axis sliders, thus guaranteeing the assembly accuracy of the X axis in Step 15–16.

14<sub>/22</sub>

Identify the last Linear Module (which is labeled with "X" on the cable connector). It will be the X axis.

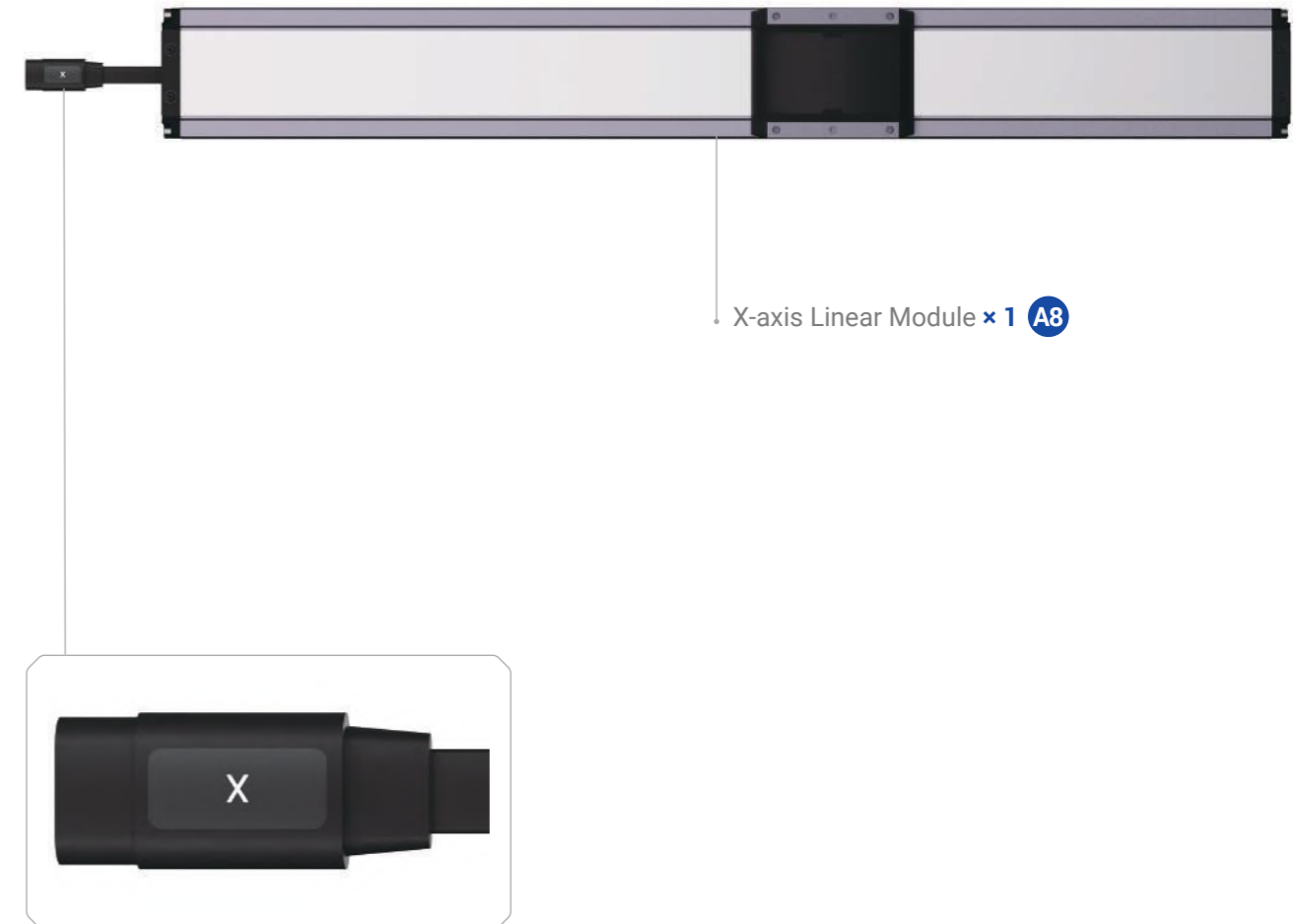

All the Linear Modules must be installed in their intended position. Incorrect installation or mixed use of the Linear Modules will result in malfunction of or damage to the machine.

**15**<sub>/22</sub> Insert the dowels of the X-axis connectors into the dowel holes of the X axis.

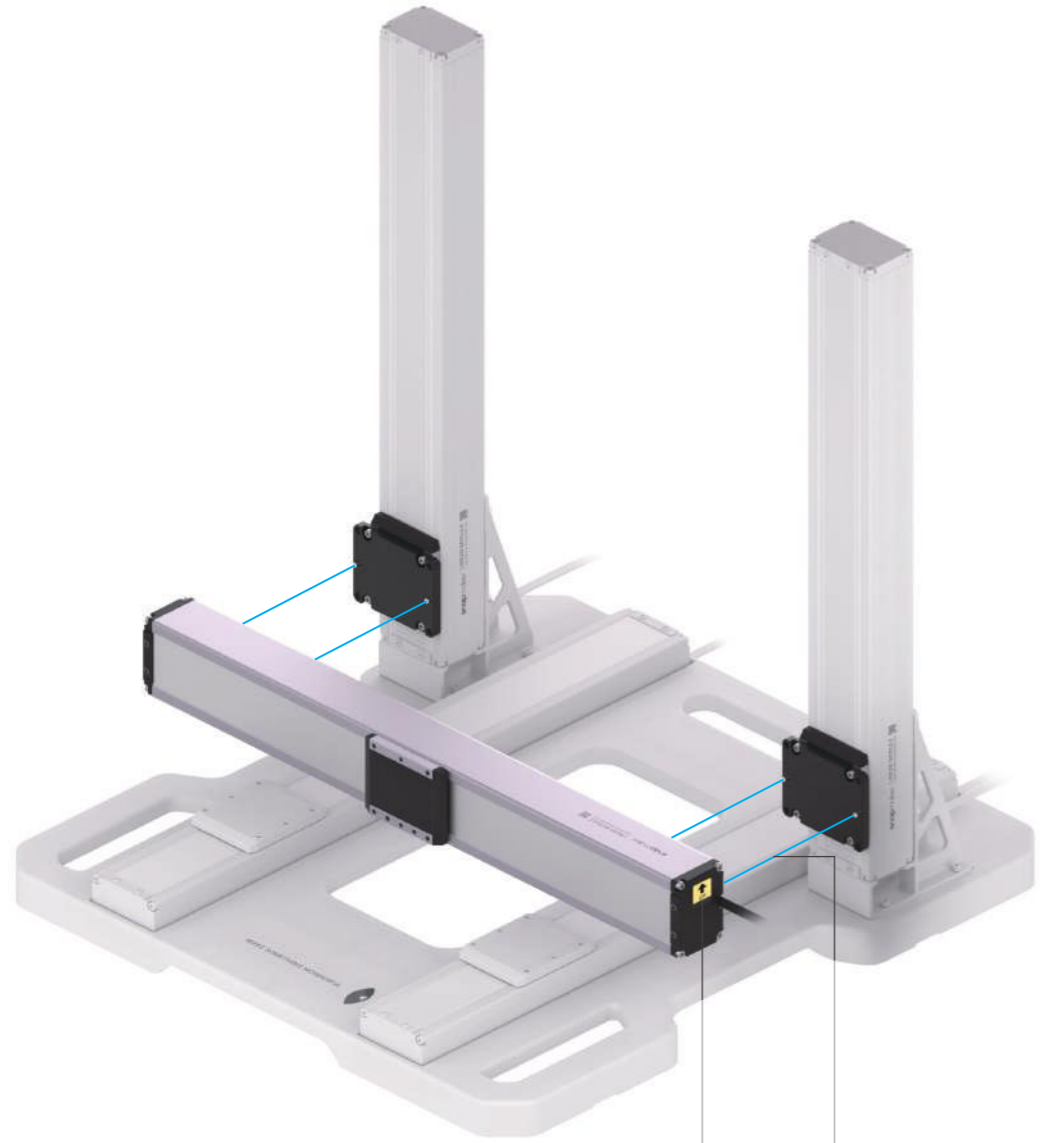

 Make sure to fully insert the dowels into the dowel holes.



**16**<sub>/22</sub> Attach the X axis to the X-axis connectors.

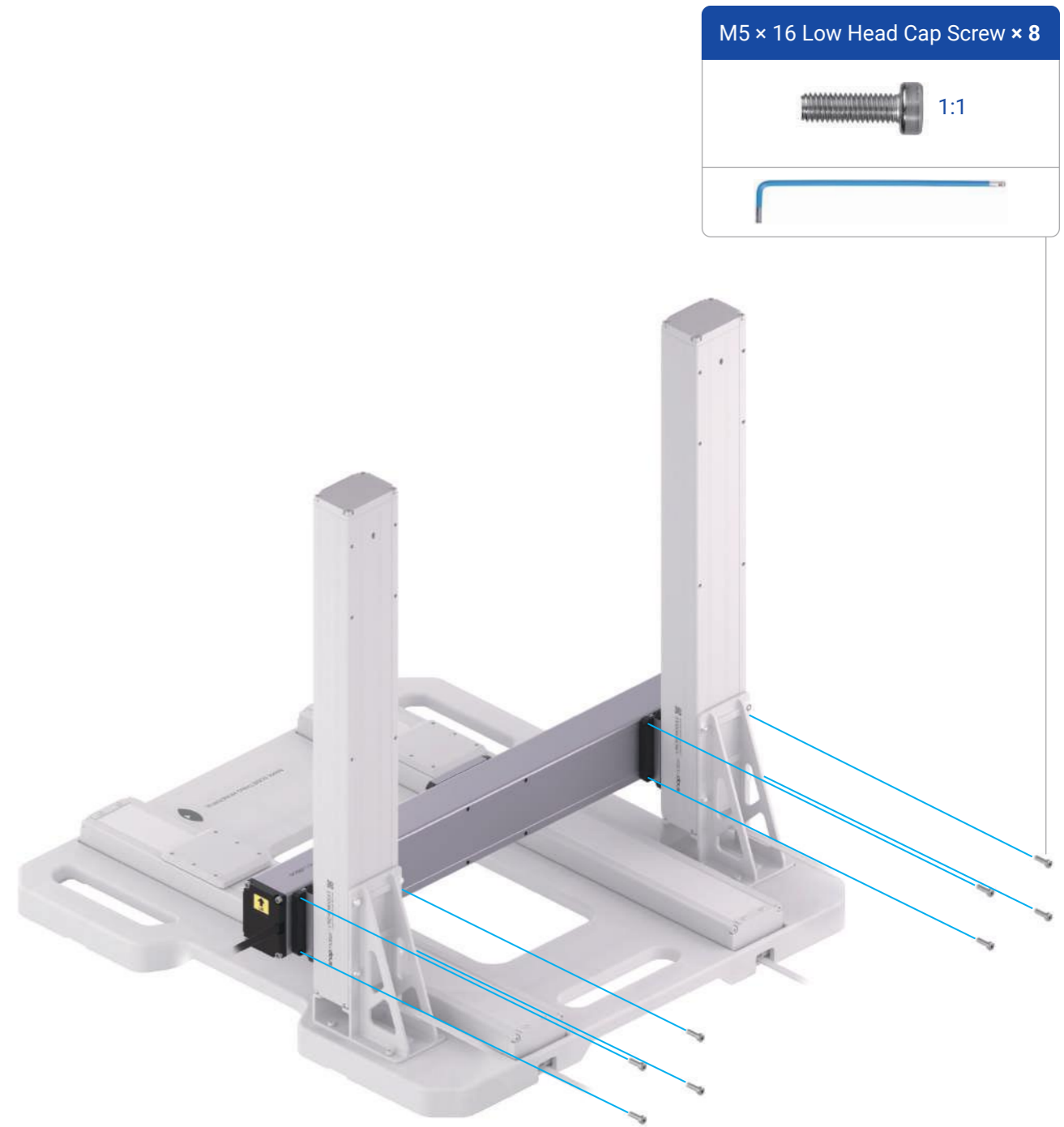

M5 × 16 Low Head Cap Screw × 8



1:1



**17** /22 Attach the three cable clips to the X axis and the Z axes.

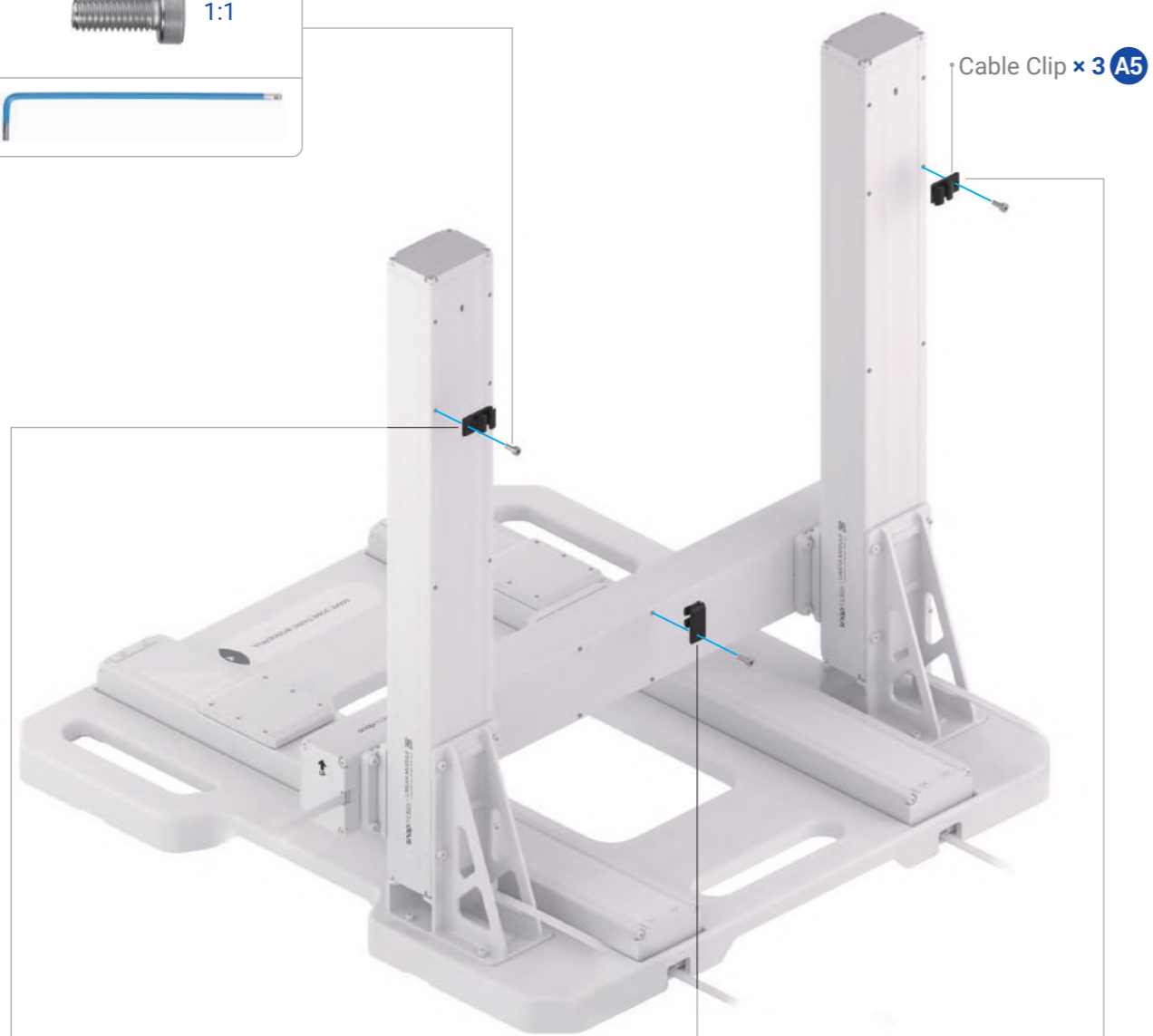
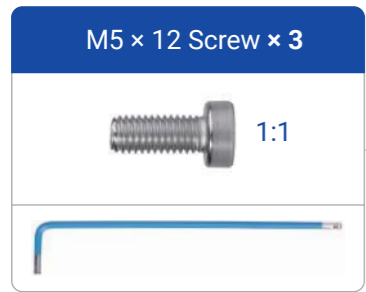

**18** /22 Press the marked positions of the X-axis cable and the toolhead cable into the cable clips.

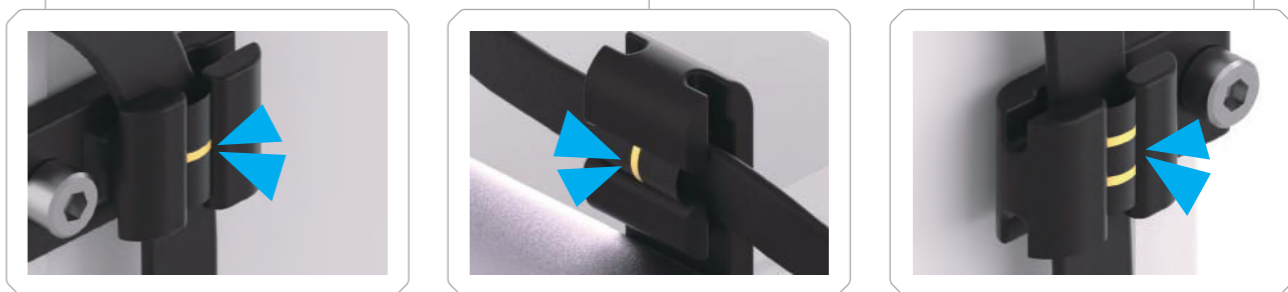

**19** /22 Attach the toolhead bracket to the X-axis slider.

M5 × 16 Flat Head Screw × 4

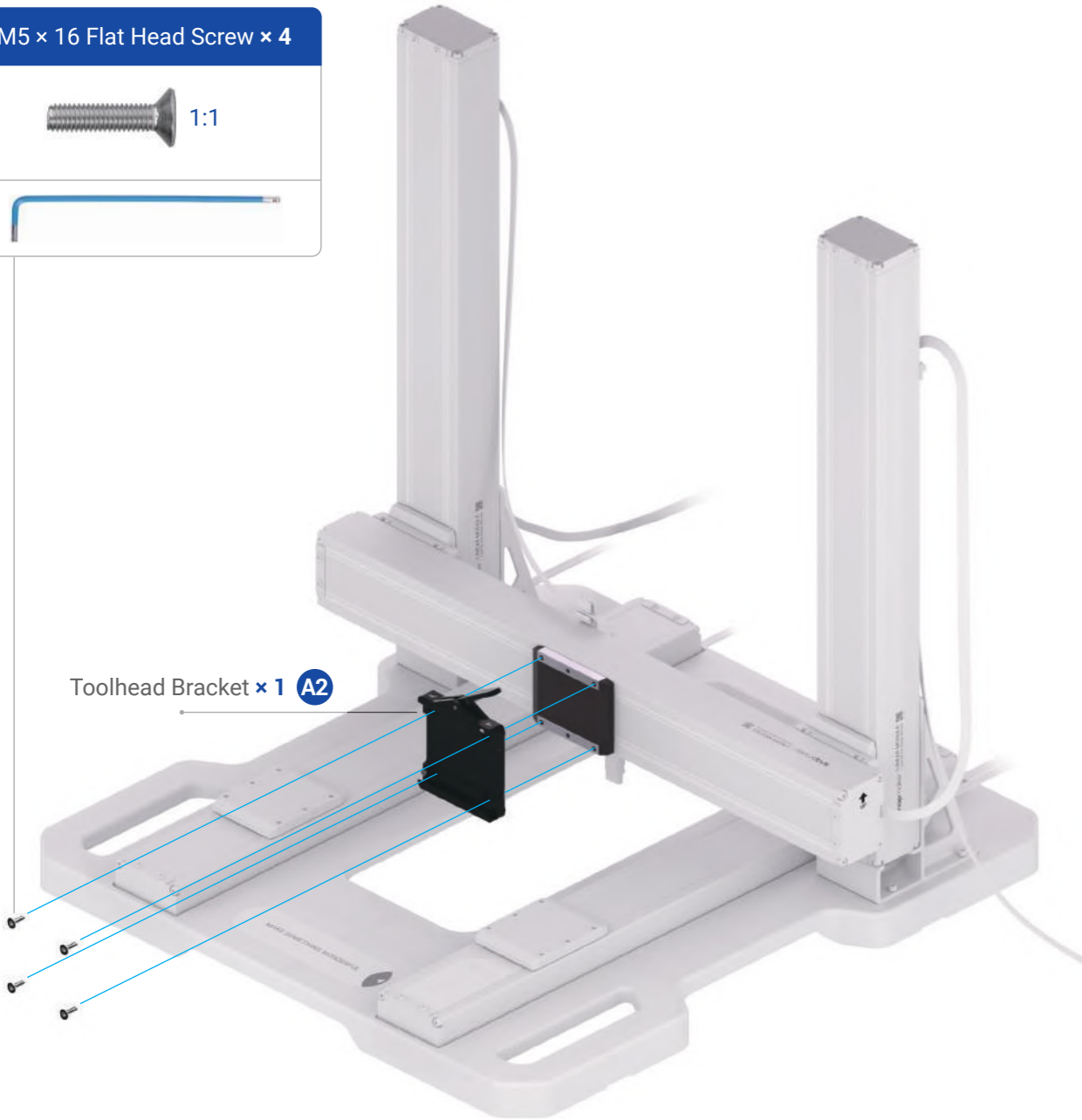

1:1

**20** /22 Move the Y-axis sliders frontward to their farthest ends.

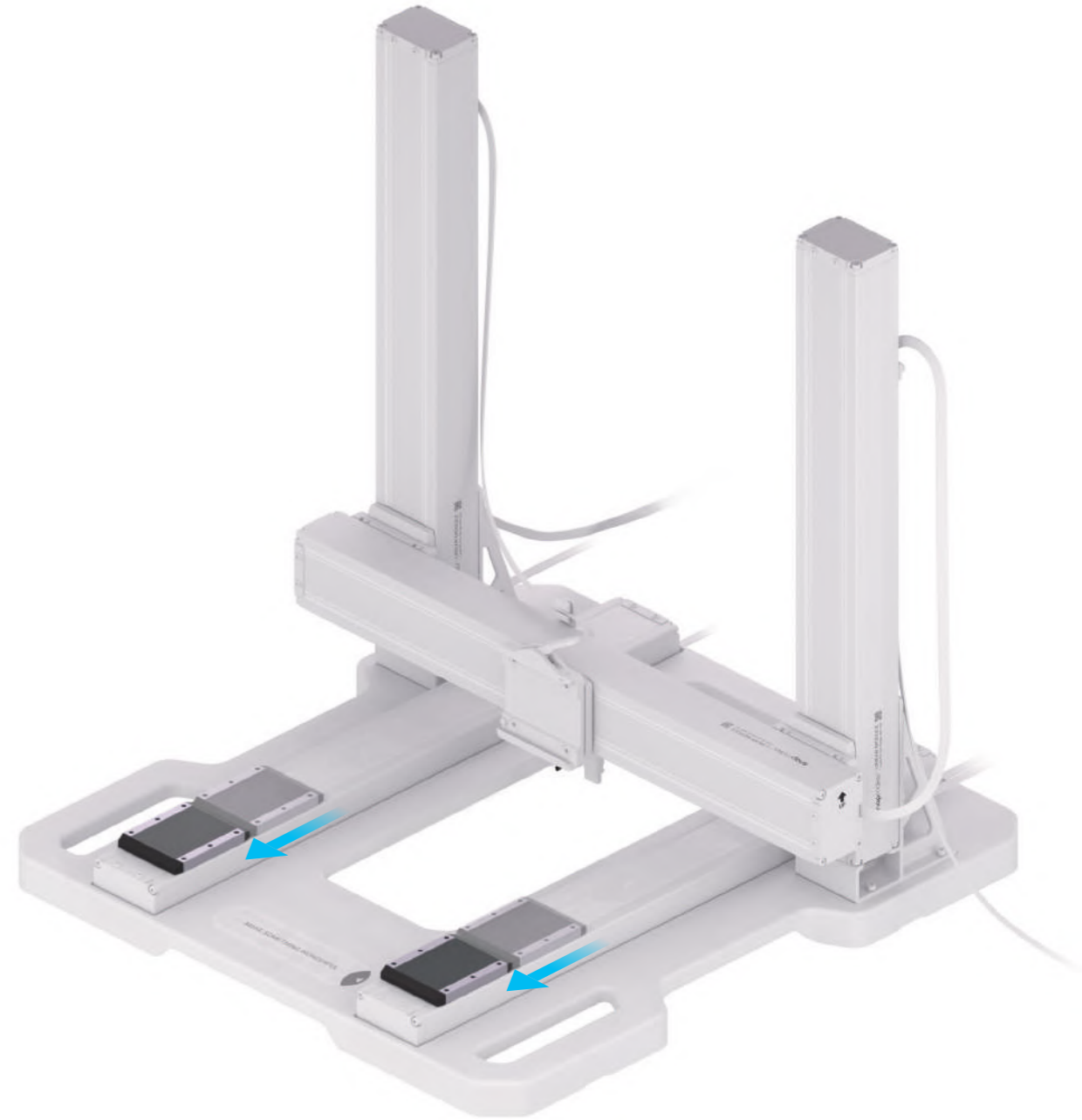

**i** This step ensures the alignment of the two Y-axis sliders, thus guaranteeing the assembly accuracy of the support platform in Step 21.



21 /22

Attach the support platform to the Y-axis sliders.

M5 × 16 Low Head Cap Screw × 8



1:1

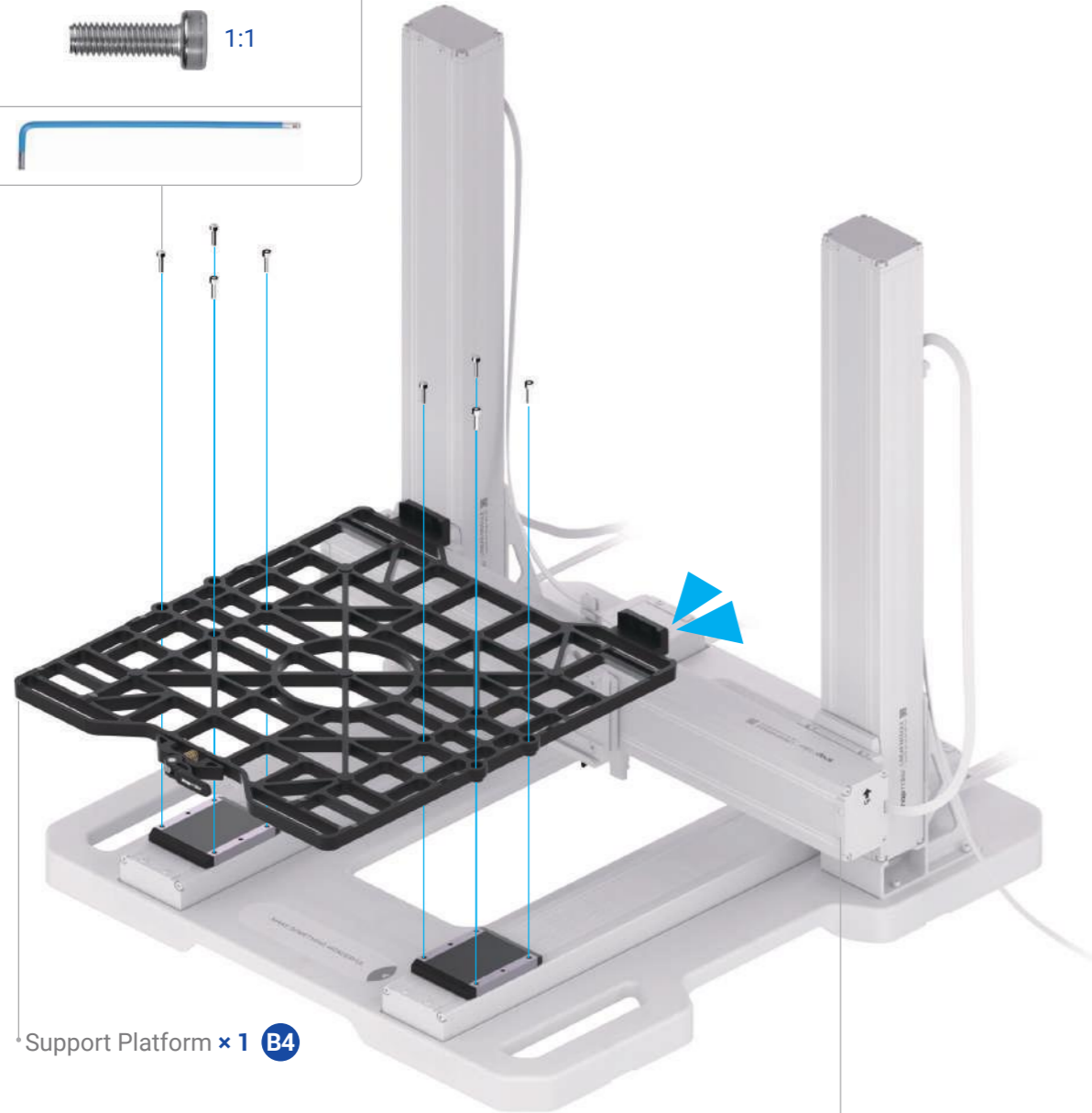

The support platform is pre-installed underneath the laser platform. Please separate them first.

To install the screws:

1. Pre-tighten the four outermost screws;
2. Pre-tighten the remaining screws;
3. Pull the support platform forward and meanwhile tighten all the screws.



22 /22

Put your hands beneath both ends of the X axis, and lift the X axis over the Z-axis holders.

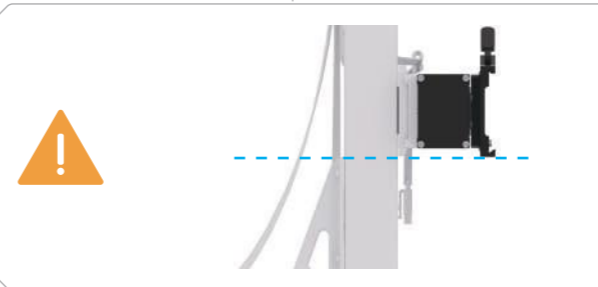

This step enables you to install the toolhead and the work platform later.

# Enclosure

## 3.1 Enclosure Assembly

- 3.1.1 Assemble the Bottom Frame
- 3.1.2 Assemble the Vertical Frame
- 3.1.3 Install Side Panels and the Top Panel Kit
- 3.1.4 Assemble the Enclosure Door
- 3.1.5 Combine the Enclosure and the Machine
- 3.1.6 Install the Back Panel and the Exhaust System
- 3.1.7 Plug, Lock, and Finish

## 3.2 Enclosure Settings

- 3.2.1 Enable/Disable Door Detection
- 3.2.2 Turn On/Off LED Strips and the Exhaust Fan



### Assemble the Bottom Frame



Well begun is half done.  
**Are you ready?**

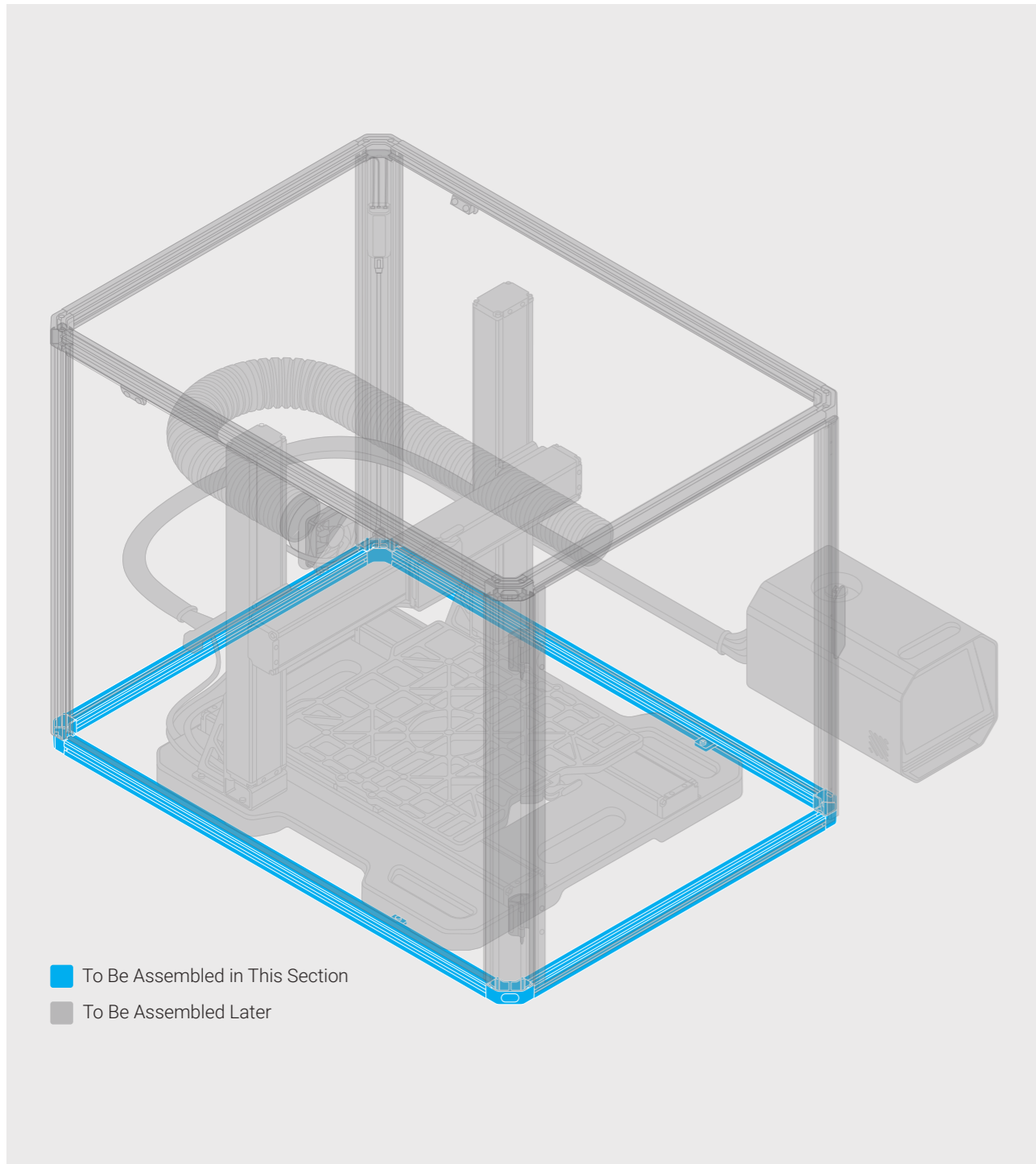

# 01

/28

Attach the two base fixtures (upper) to the two long beams.

M4 × 20 Screw × 2



1:1

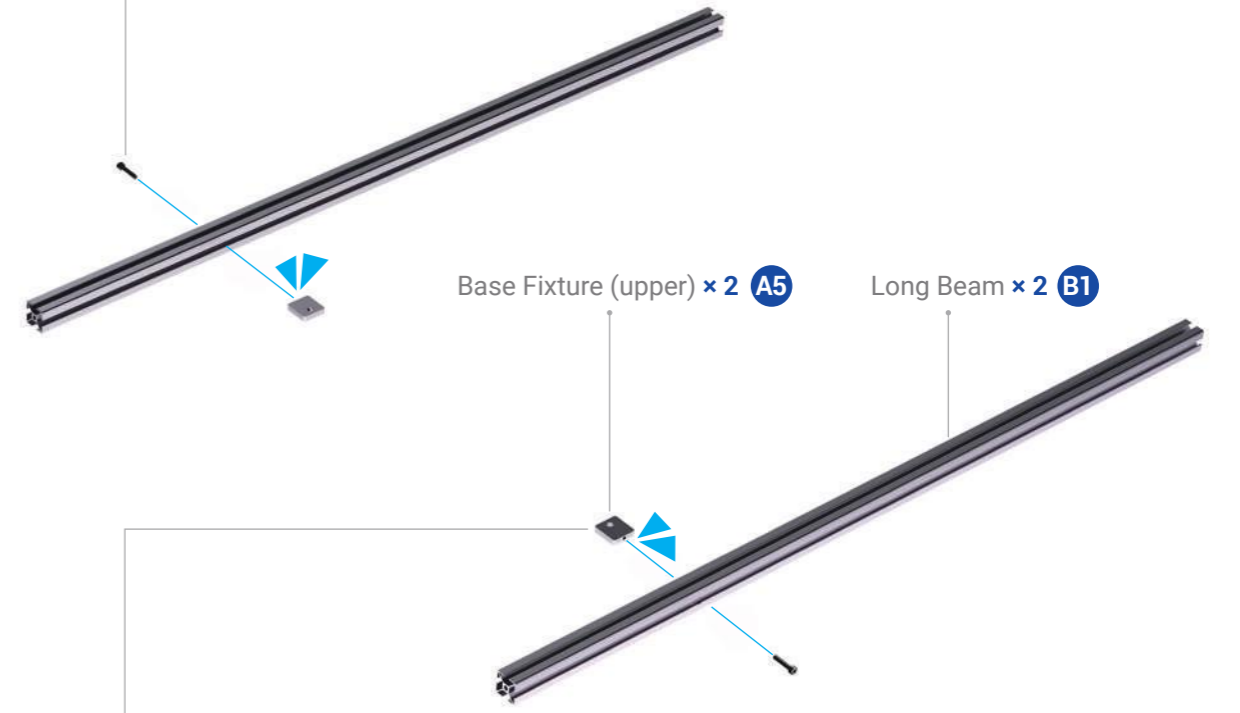

Ensure that the side of the beam with the screw cutout faces outwards.

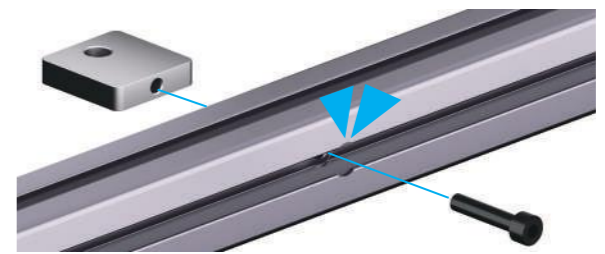

02 /28

Attach the profile connectors to both ends of the long beams.

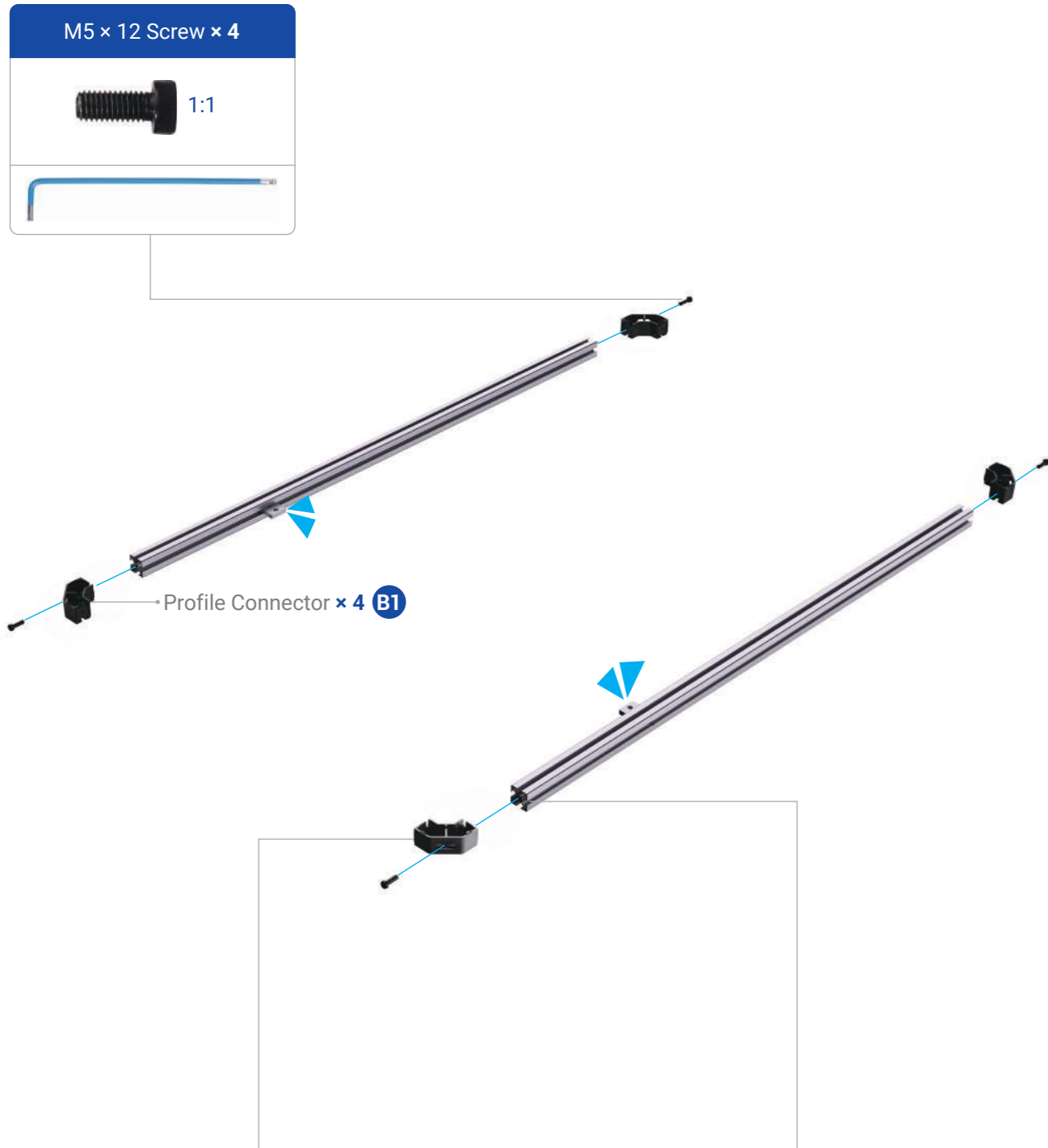

03 /28

Attach the short beam (rear) to the profile connectors.

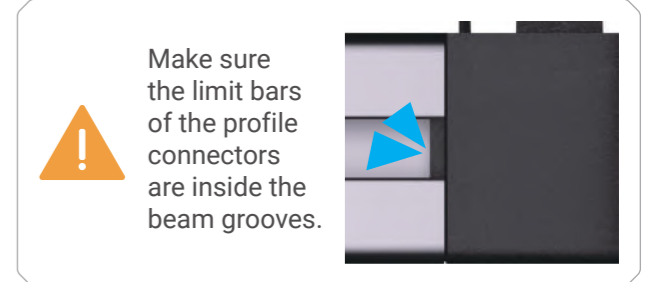
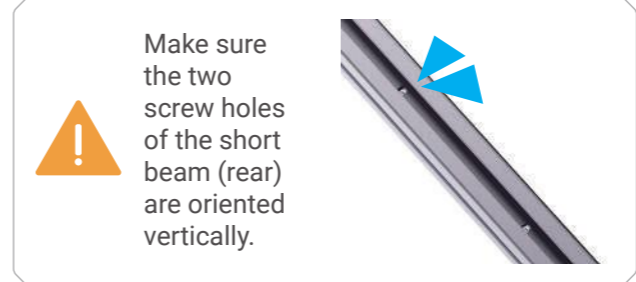



04<sub>/28</sub>

Attach the short beam (front) to the profile connectors.

M5 × 12 Screw × 2



1:1

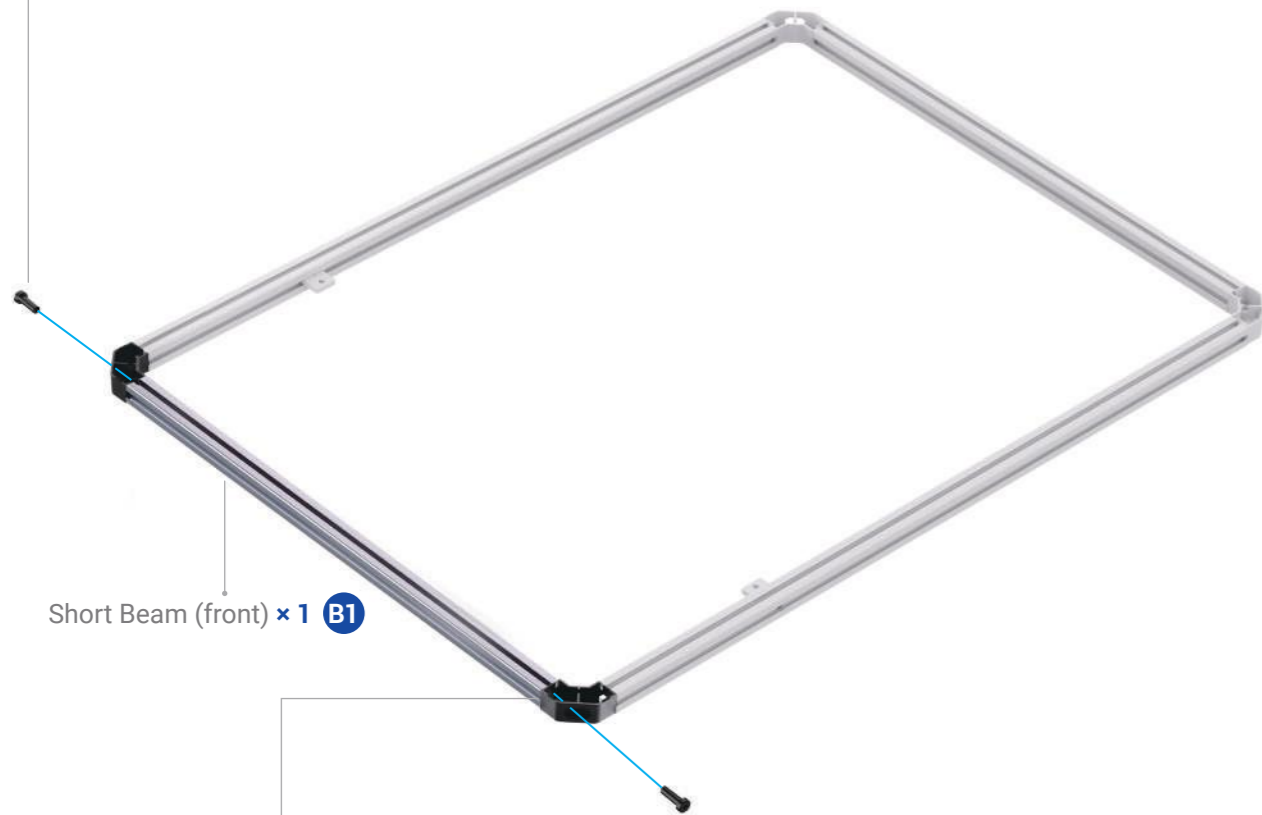

Short Beam (front) × 1 **B1**



Make sure the limit bars of the profile connectors are inside the beam grooves.



Assemble the Vertical Frame

Let's install the columns and **Complete 30% of the race!**

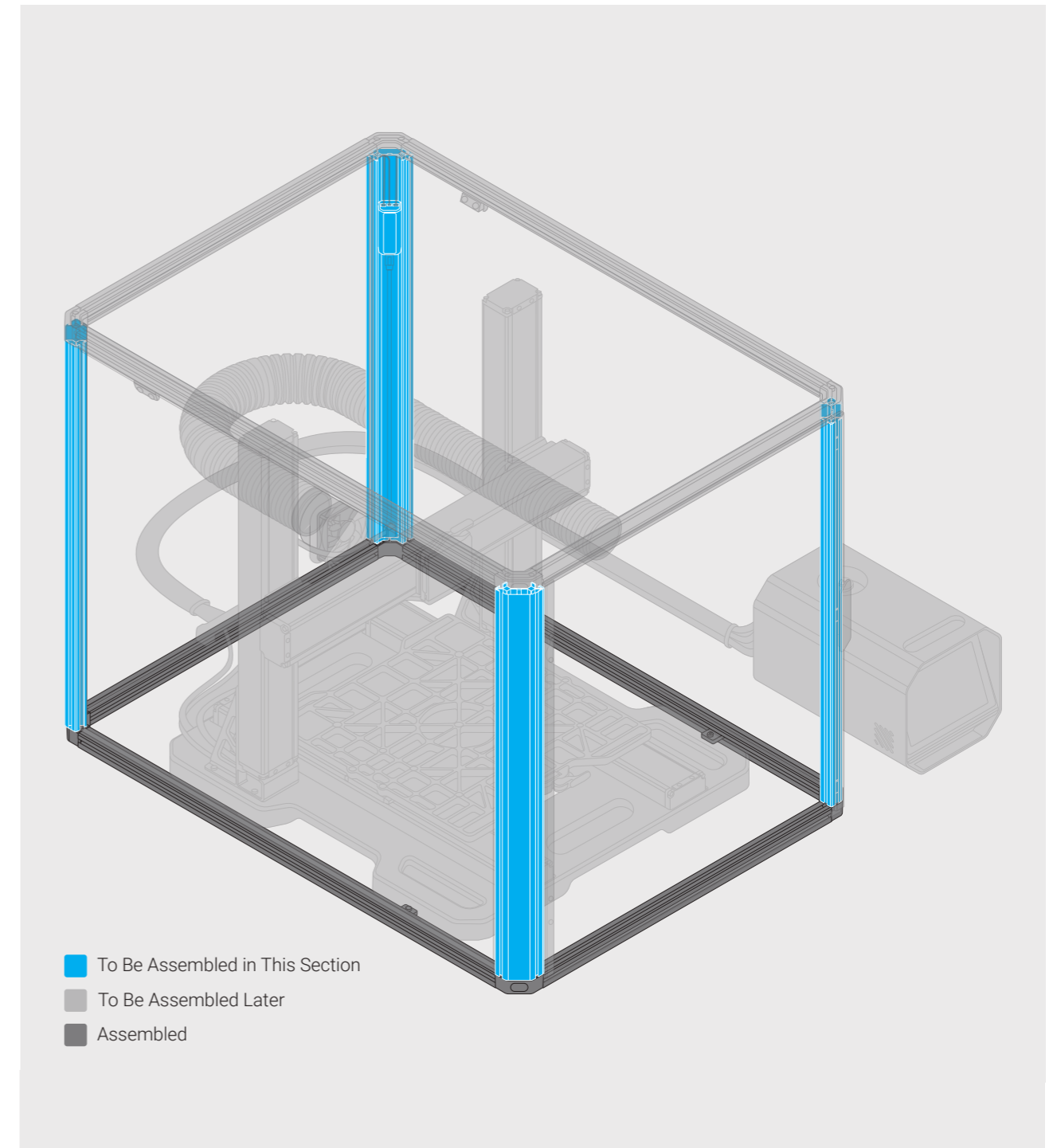

**05**<sub>/28</sub> Attach the column-1 (with hinge) to the bottom frame.

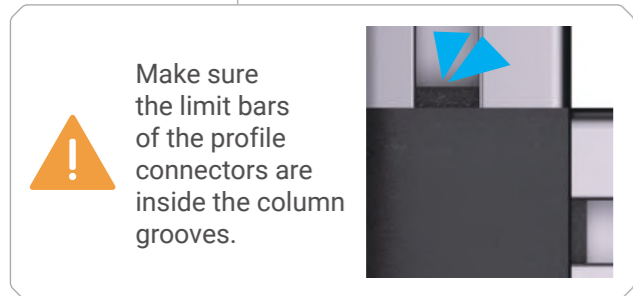
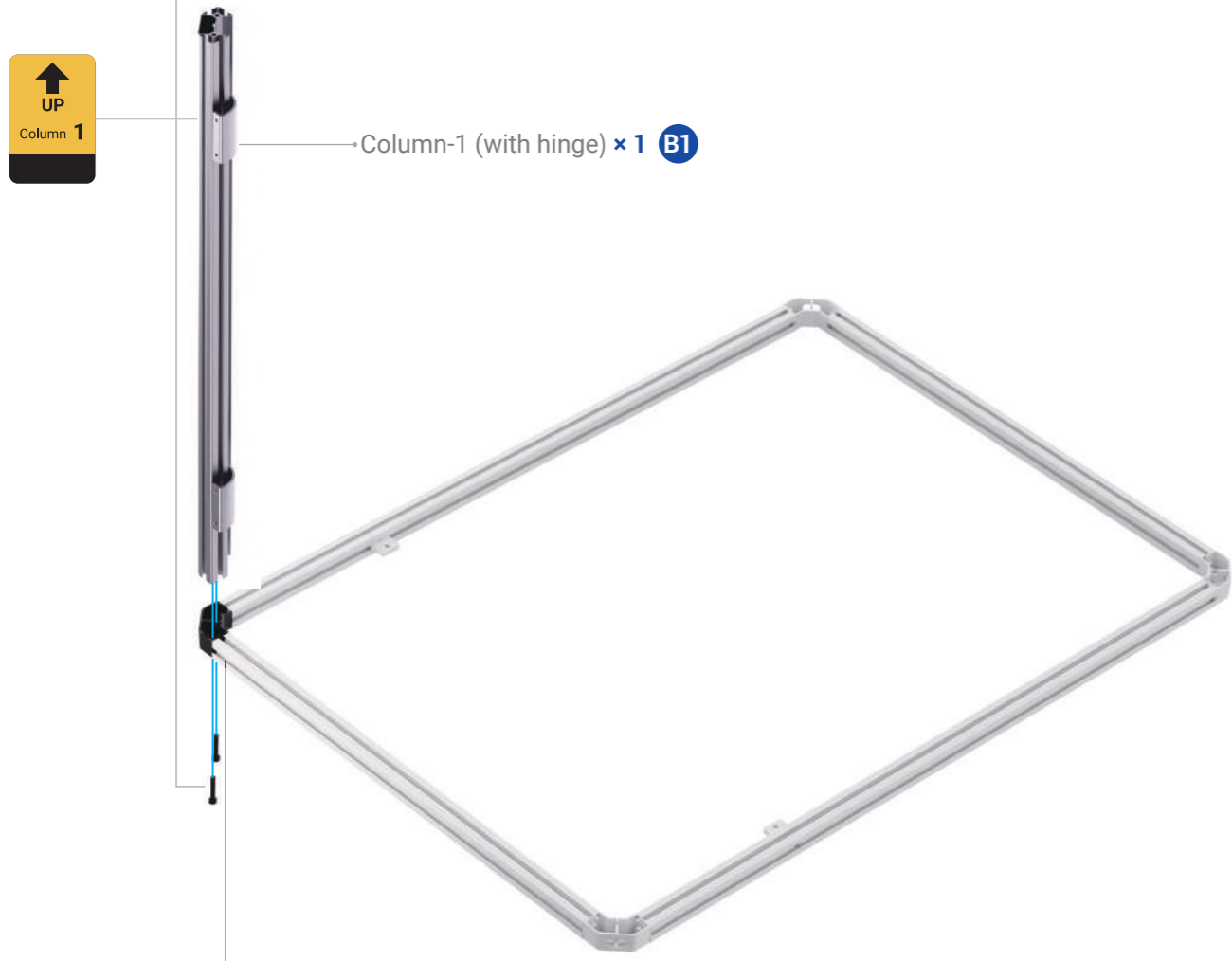
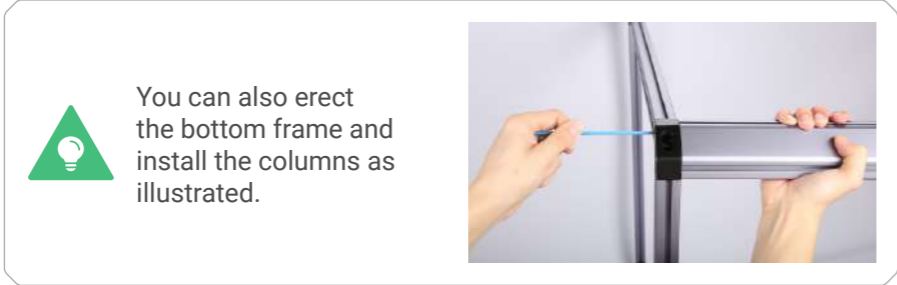
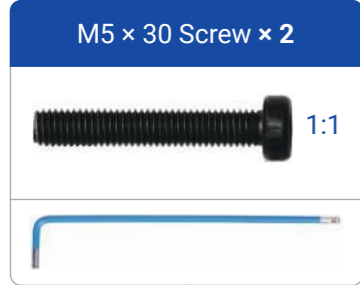

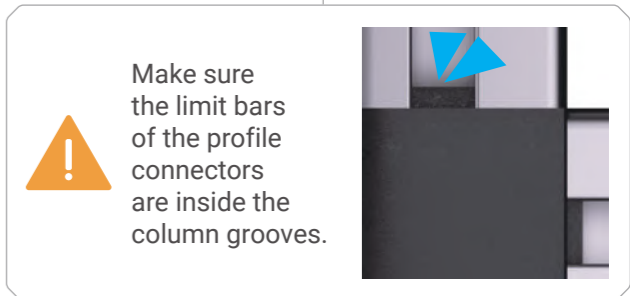
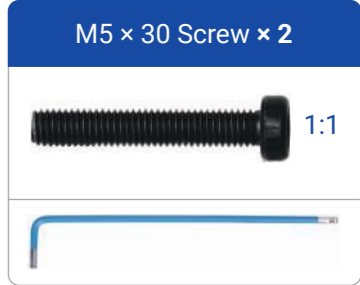

**06**<sub>/28</sub> Attach the column-2 (with hall switch) to the bottom frame.

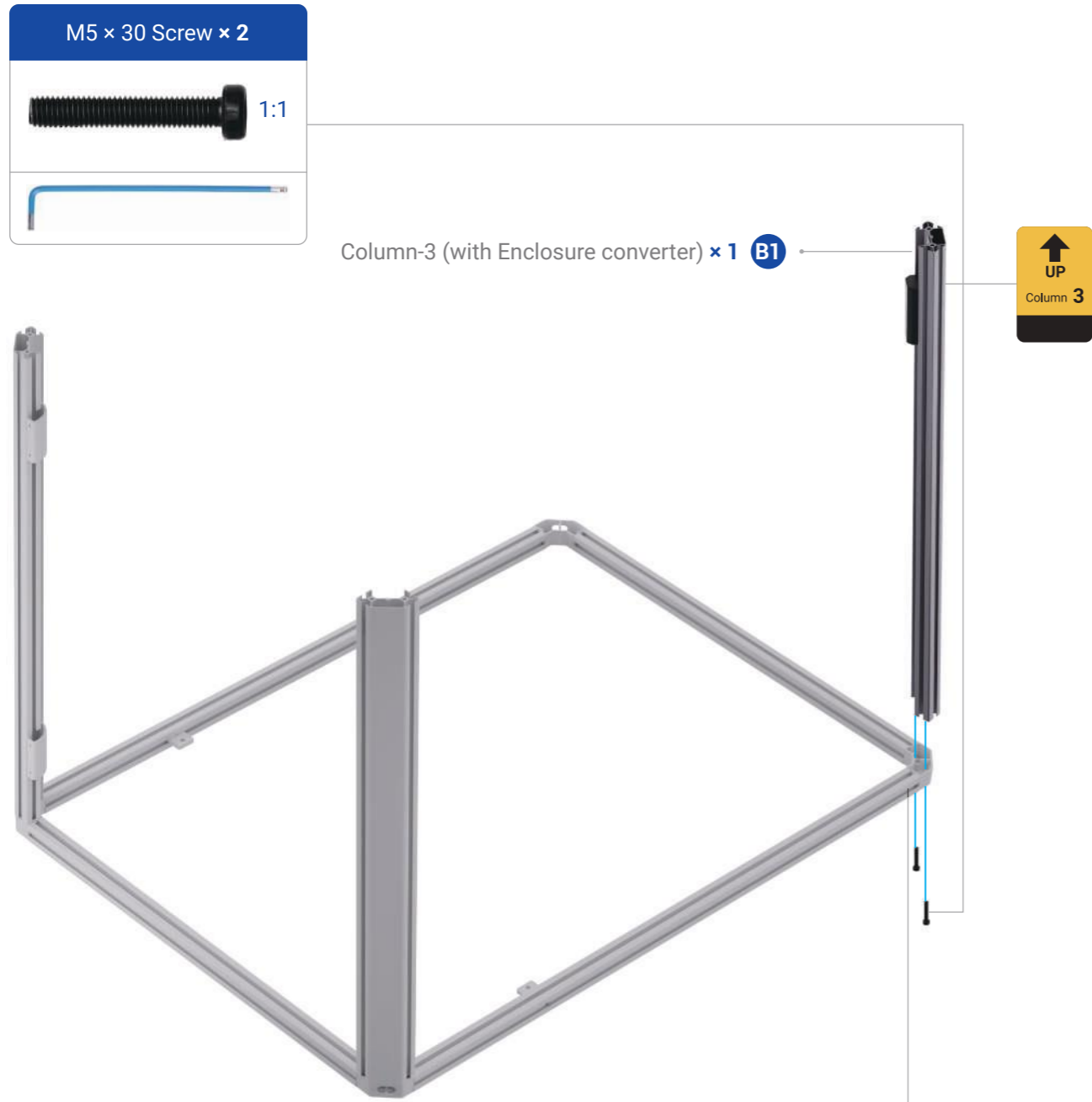

# 07 /28

Attach the column-3 (with Enclosure converter) to the bottom frame.



 Make sure the limit bars of the profile connectors are inside the column grooves.

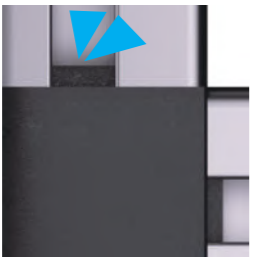

# 08 /28

Attach the column-4 to the bottom frame.

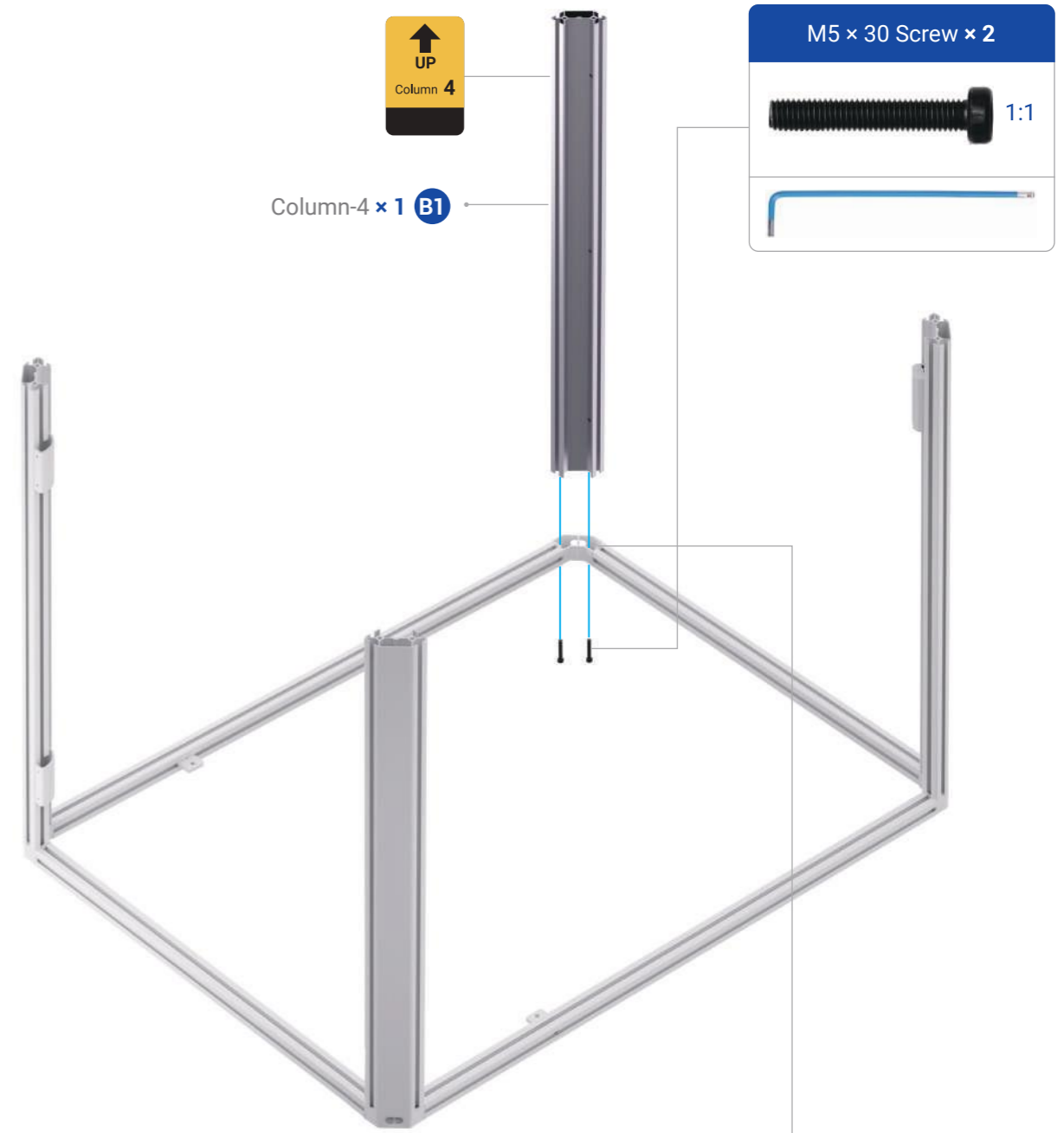

 Make sure the limit bars of the profile connectors are inside the column grooves.





09 /28

Check the illustrated features to ensure that all the beams and columns are installed correctly.



Make sure the screw holes of the short beam (rear) are oriented vertically.

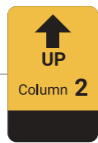
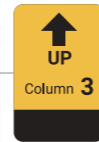
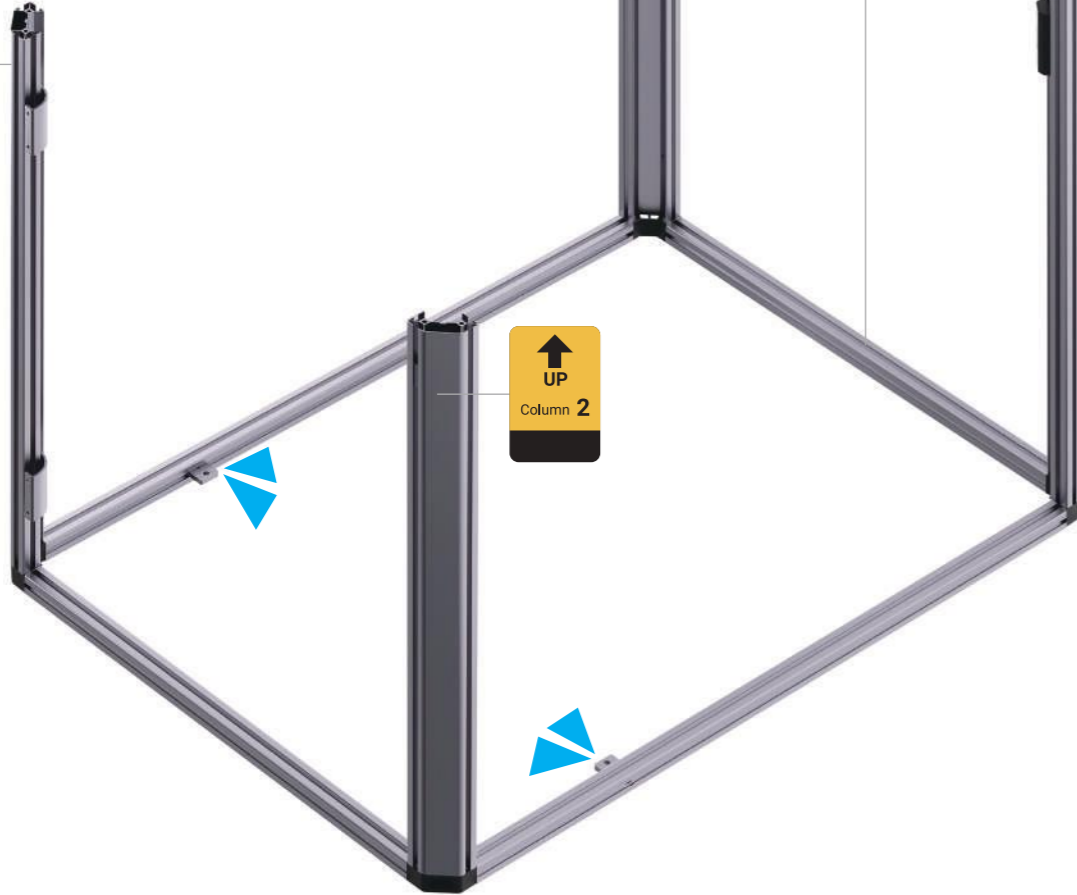
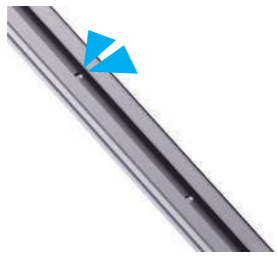

Make sure that the limit bars of the profile connectors are inside the grooves of the beams and columns.



Install Side Panels and the Top Panel Kit

Great job!  
You've assembled the basic frame.  
**The midpoint line is ahead!**

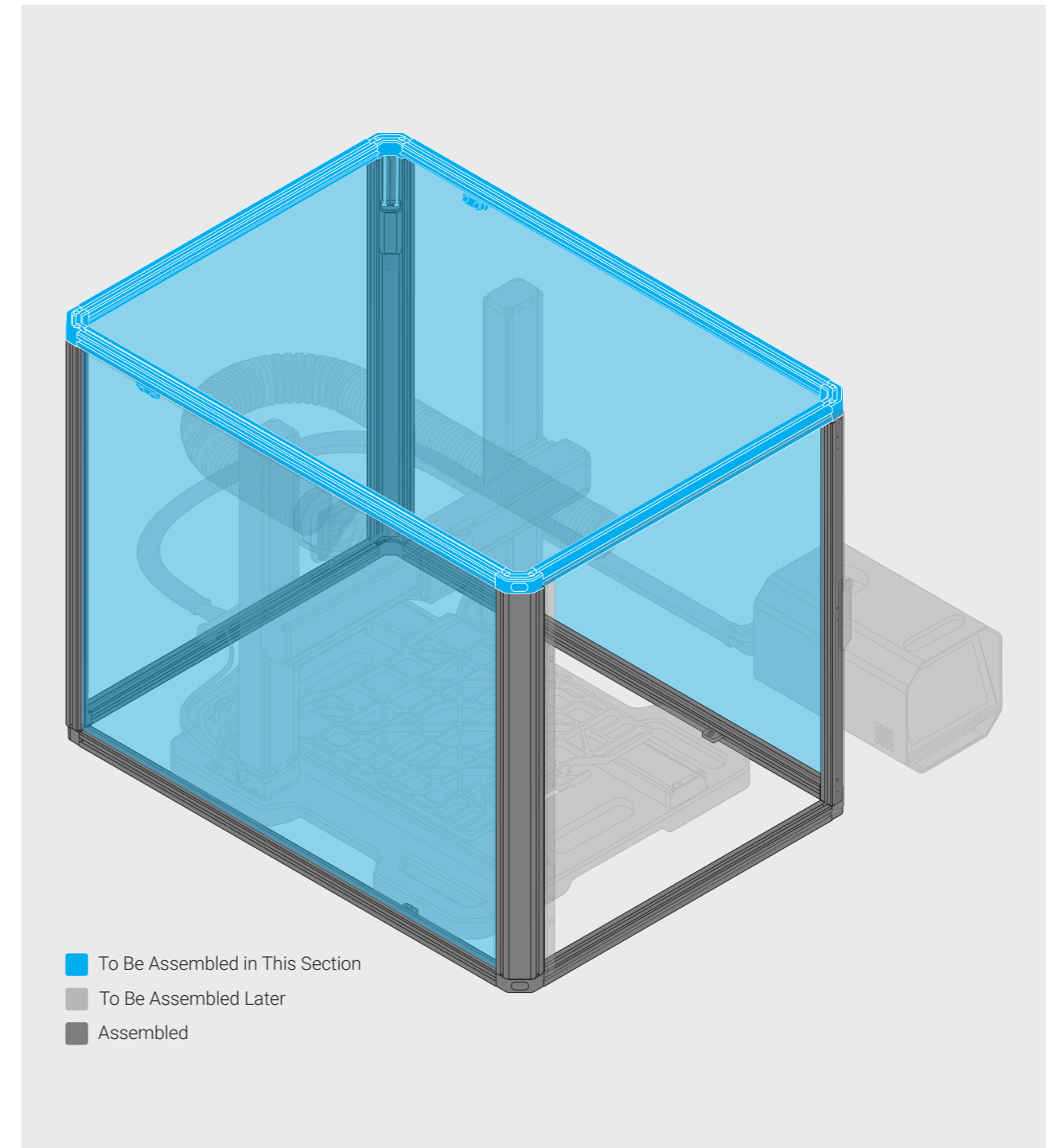



**10** /28 | Insert the two side panels into the frame.

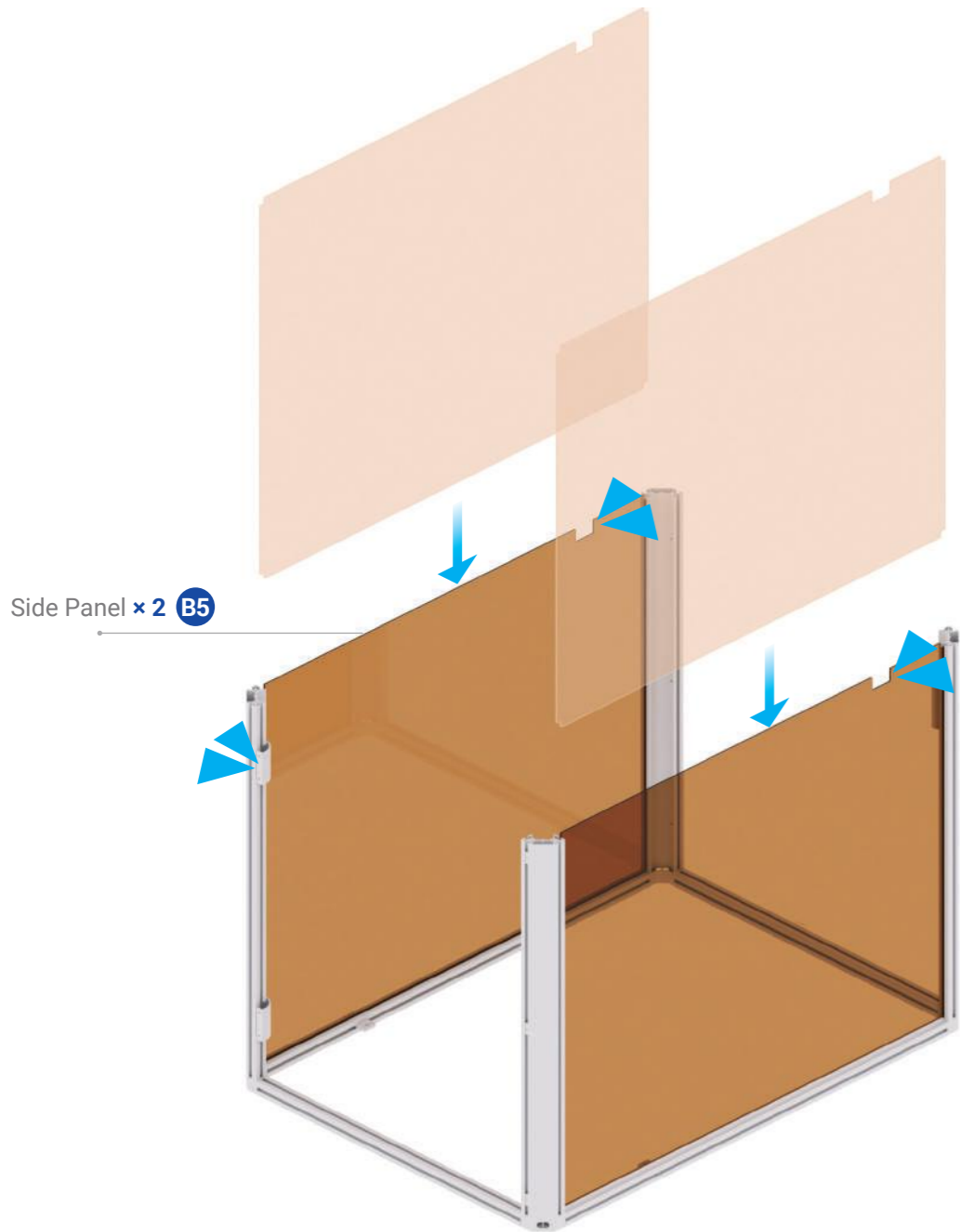

 Make sure the left, right and bottom edges of the side panels are inserted into the grooves of the corresponding profiles.



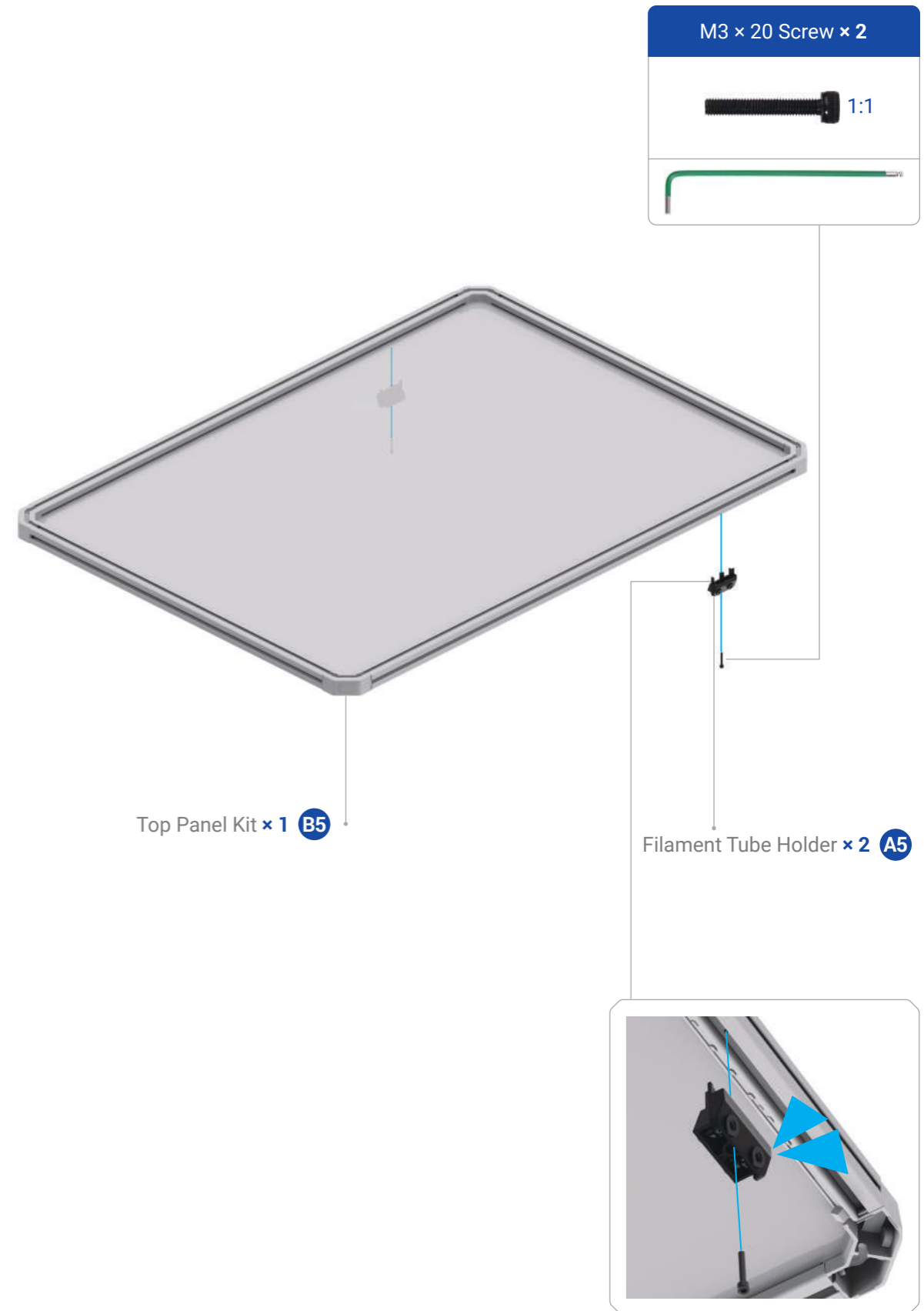

**11** /28 | Attach the filament tube holder to the top panel kit.

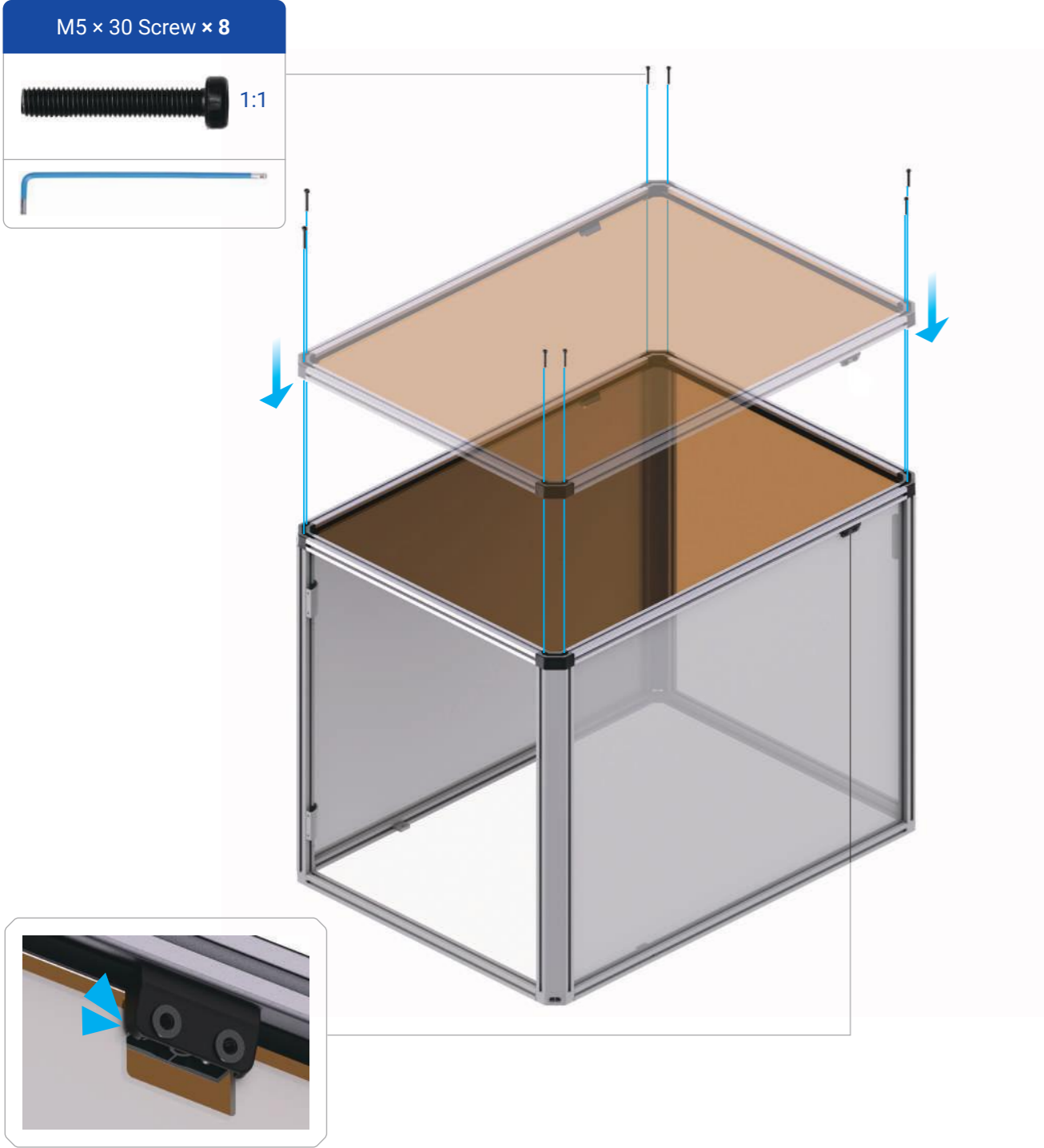

**12**<sub>/28</sub> Attach the top panel kit to the frame.



 Make sure to insert the top edges of the side panels into the grooves of the corresponding beams.

 It is recommended to pre-tighten all the screws first and then fully tighten them.

**13**<sub>/28</sub> Connect the LED strips and the hall switch to the Enclosure converter.

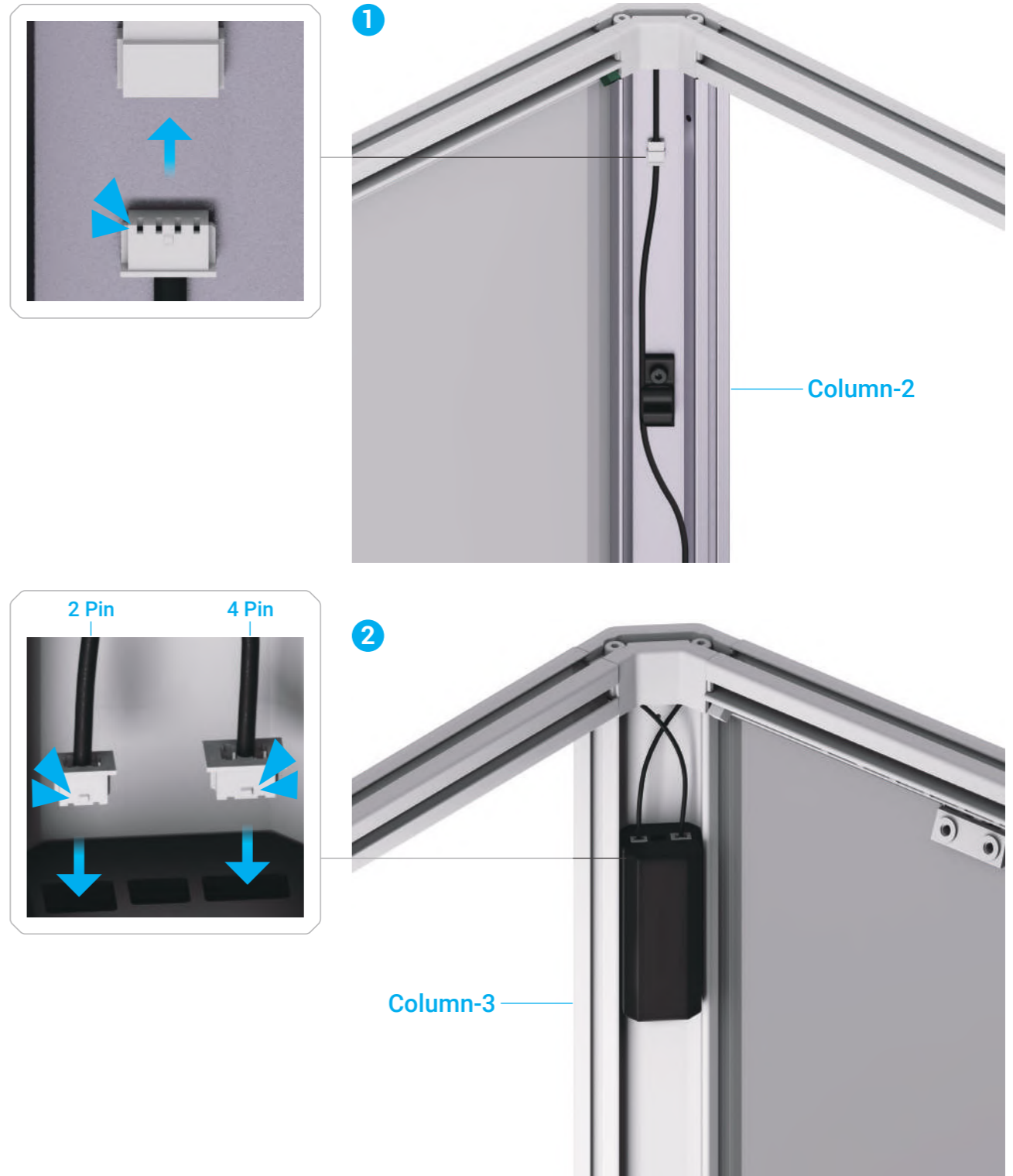

1

2

Column-2

Column-3

Assemble the Enclosure Door



# 50% Achieved!

Take a break,  
and start the second half of the game.

14<sub>/28</sub>

Attach the door handle to the Enclosure door.

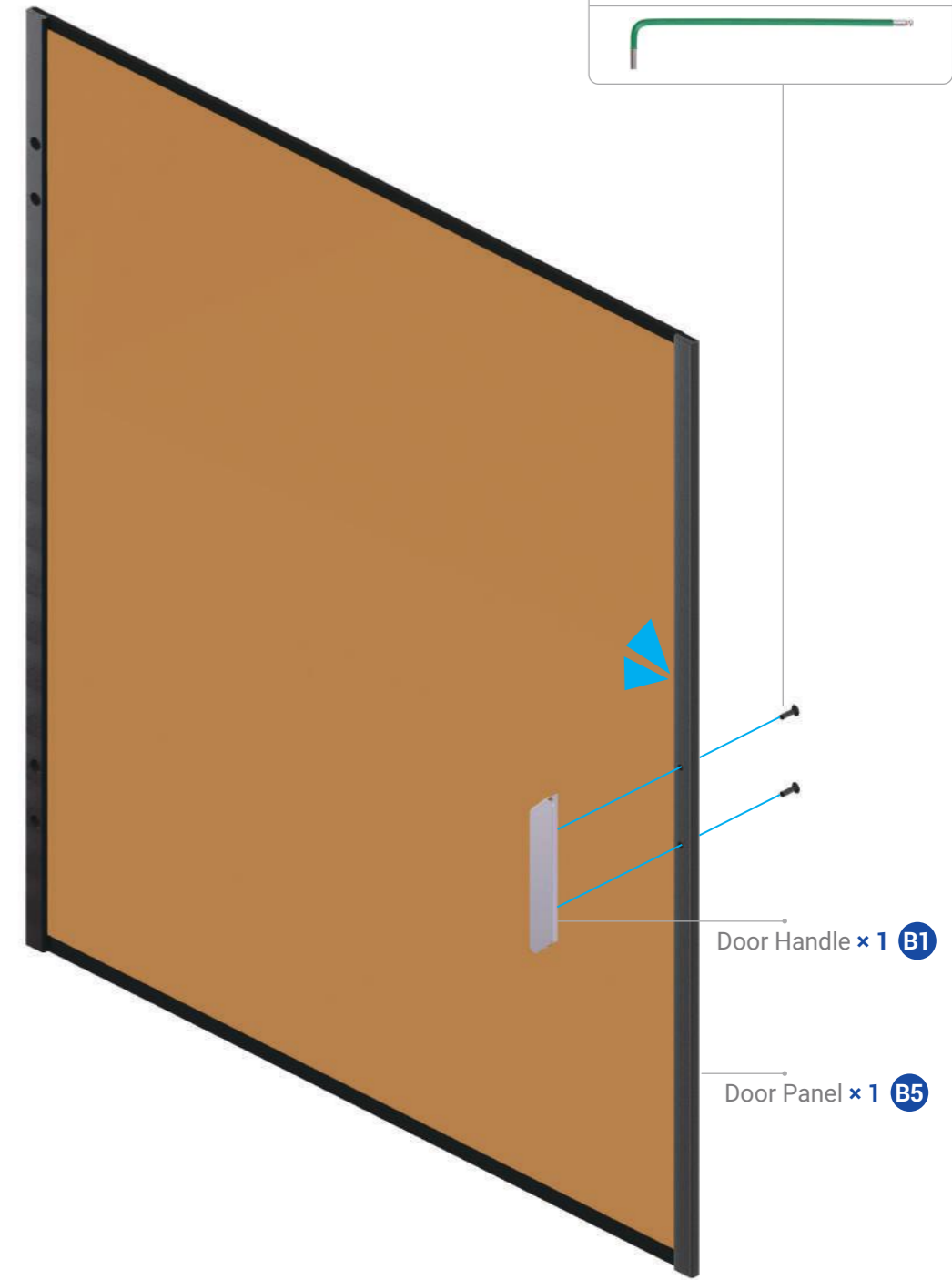
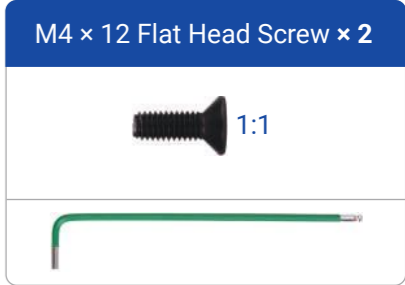
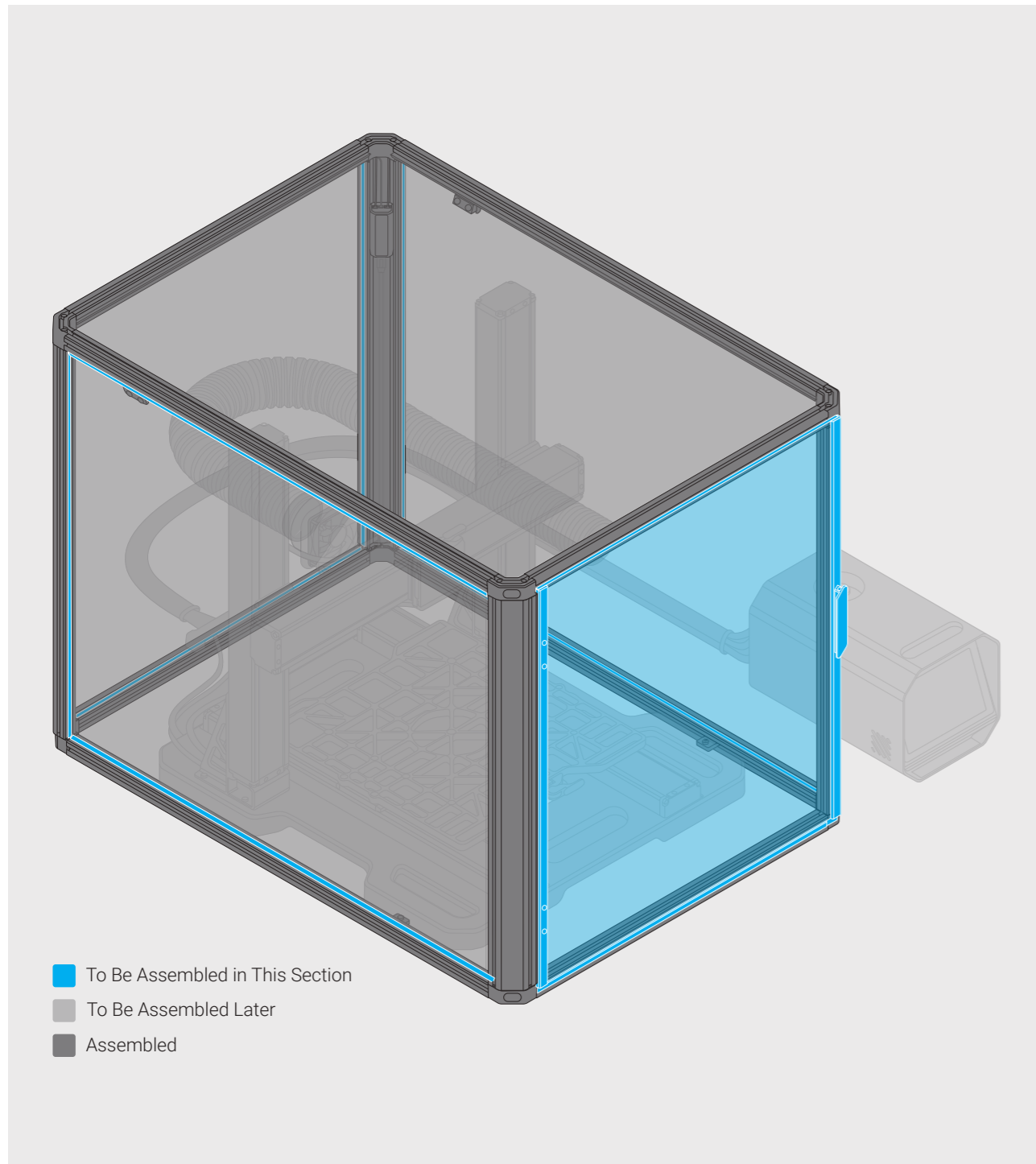

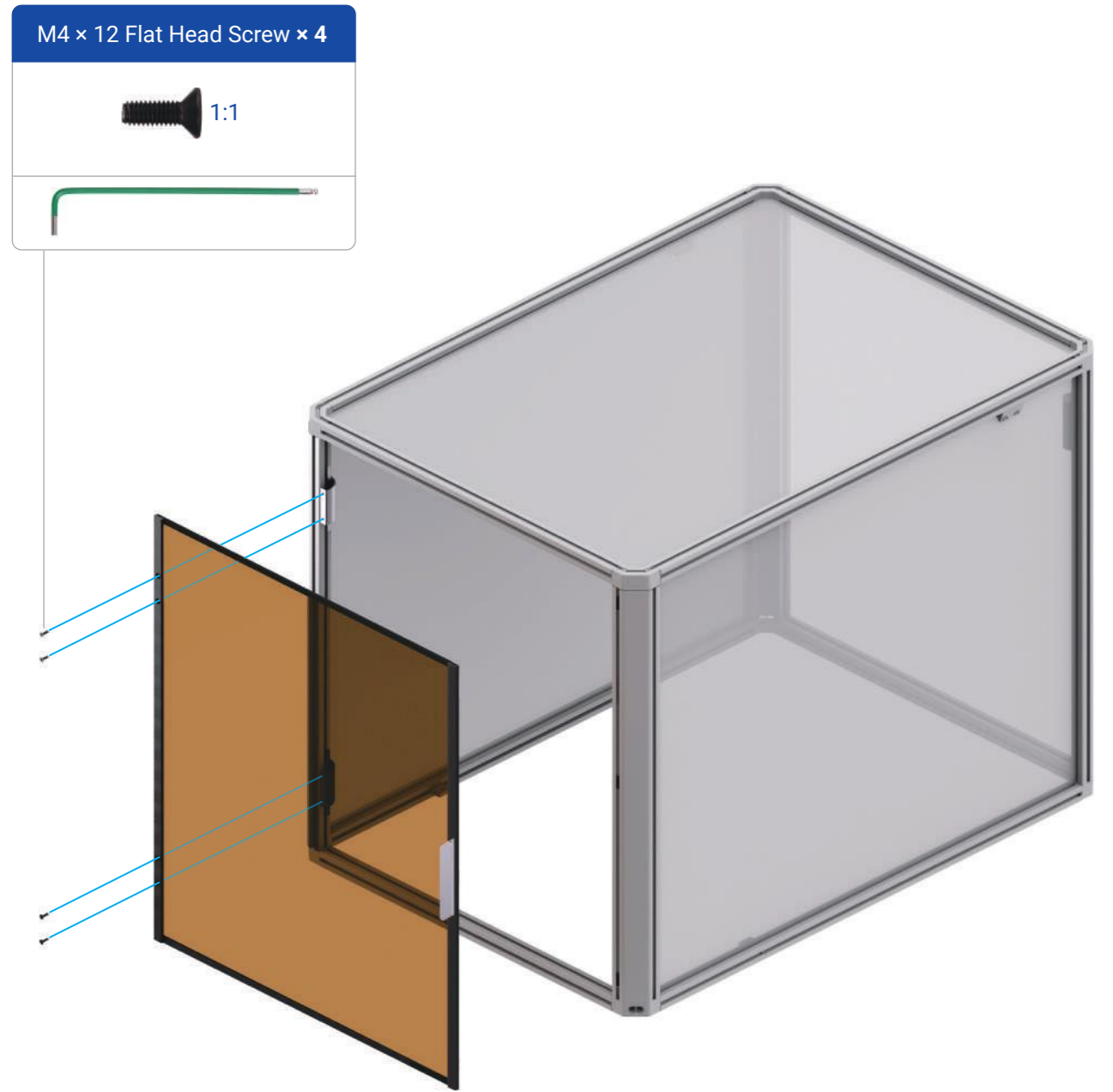

**15**<sub>/28</sub> Attach the Enclosure door to the frame.

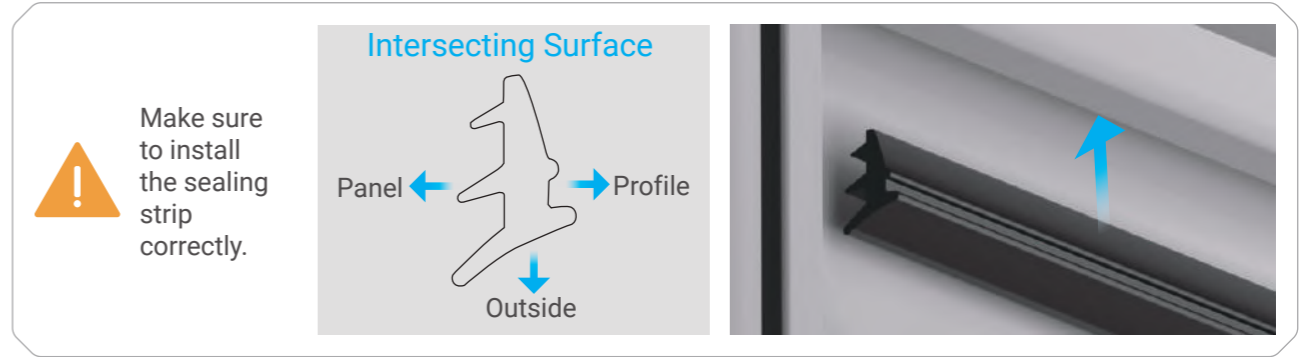
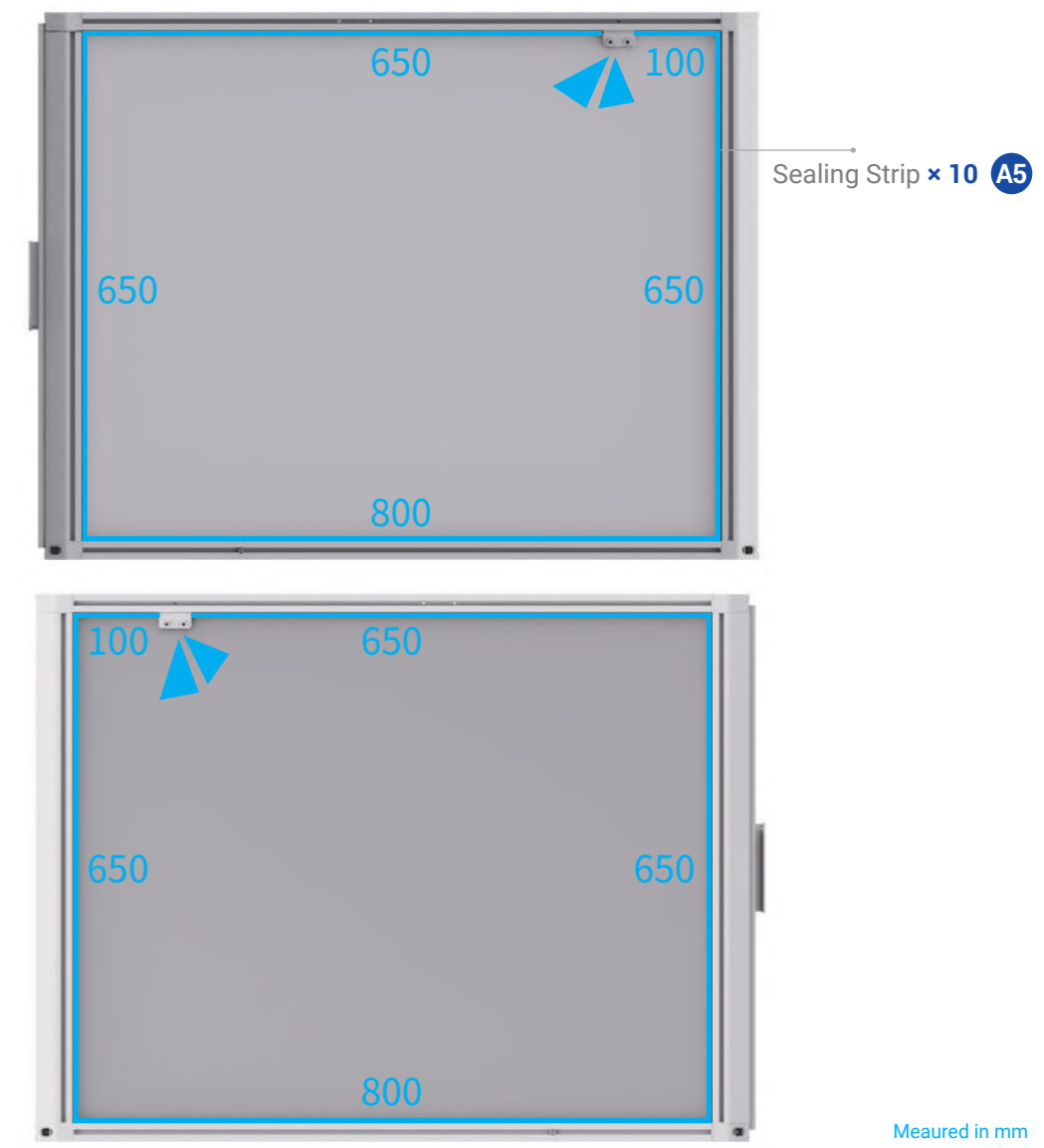

 It is recommended to pre-tighten the uppermost and lowermost screws first, then pre-tighten the remaining screws, and finally tighten all the screws in the pre-tightening order.

**16**<sub>/28</sub> Cut ten sealing strips and press them into the outer gaps between the side panels and their adjacent profiles, respectively.



 The sealing strips can help steady the panel in the frame.

Combine the Enclosure and the Machine



Awesome!  
**Less than half left.**

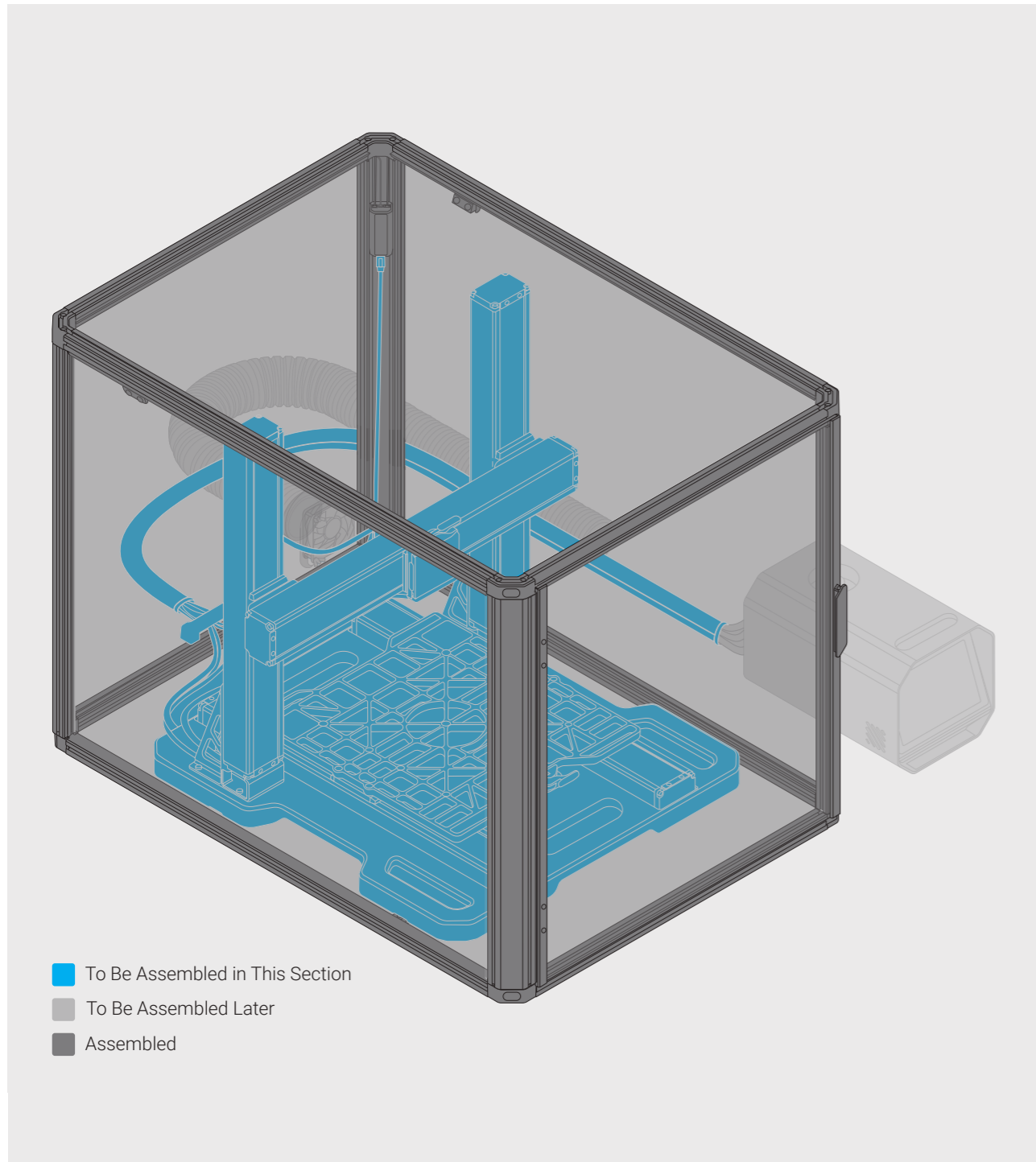

- To Be Assembled in This Section
- To Be Assembled Later
- Assembled

**17** /28

Insert the two base fixtures (lower) underneath the left and the right sides of the base plate.

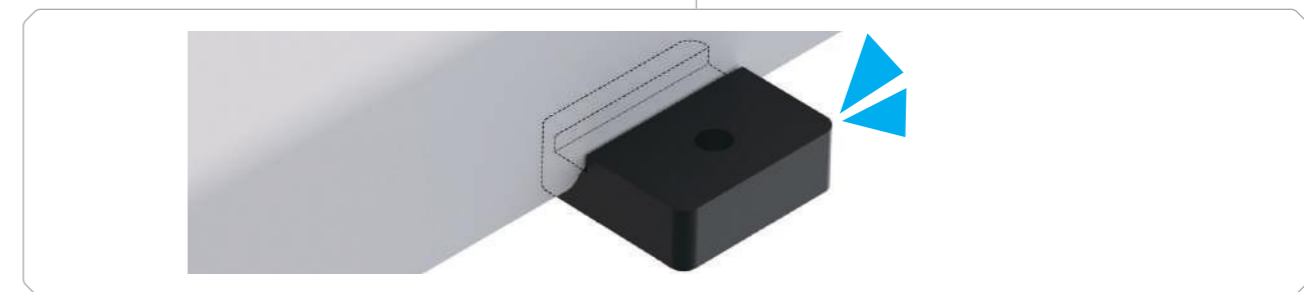
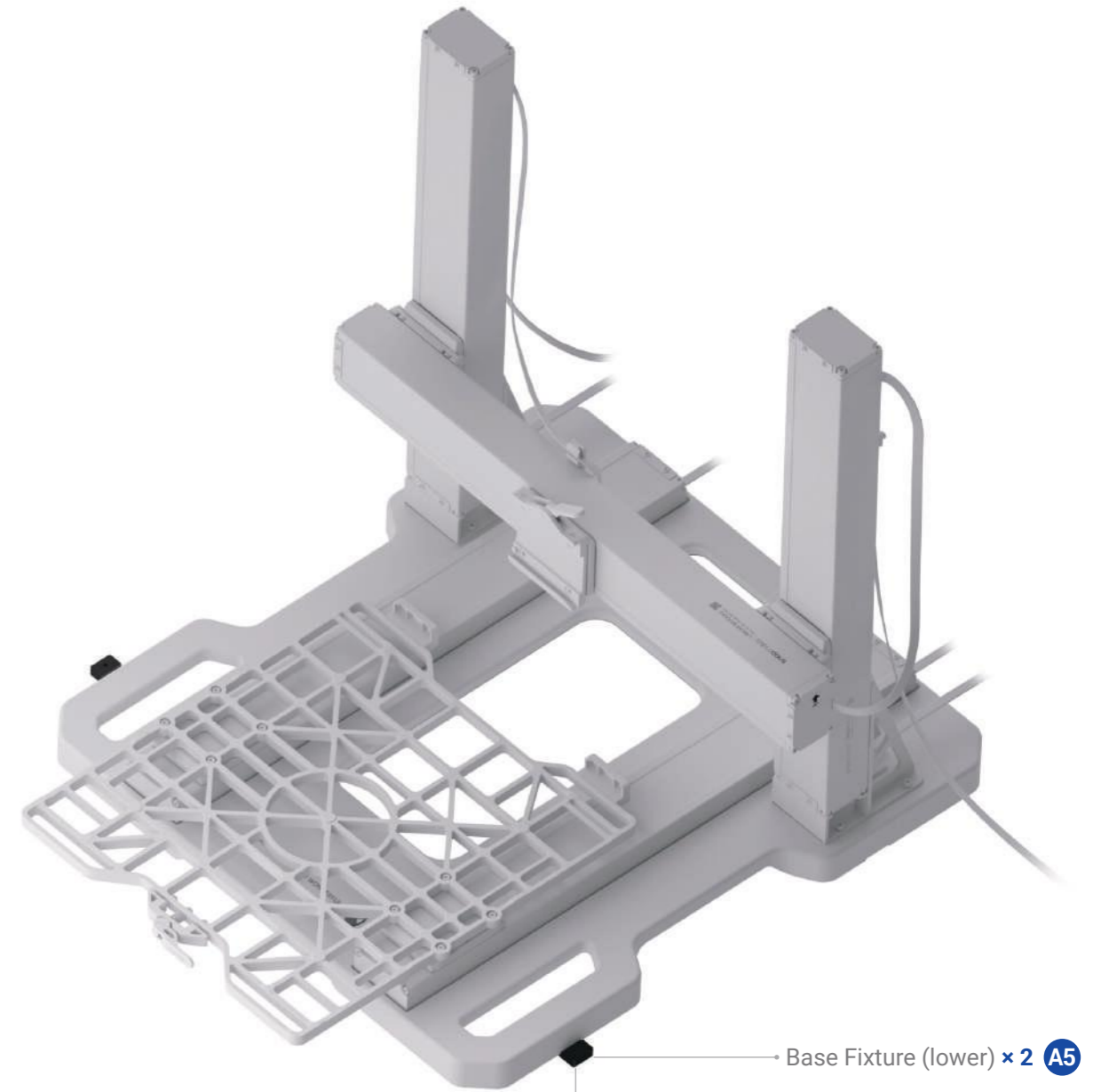

**18** /28 Cover the machine with the Enclosure from above.

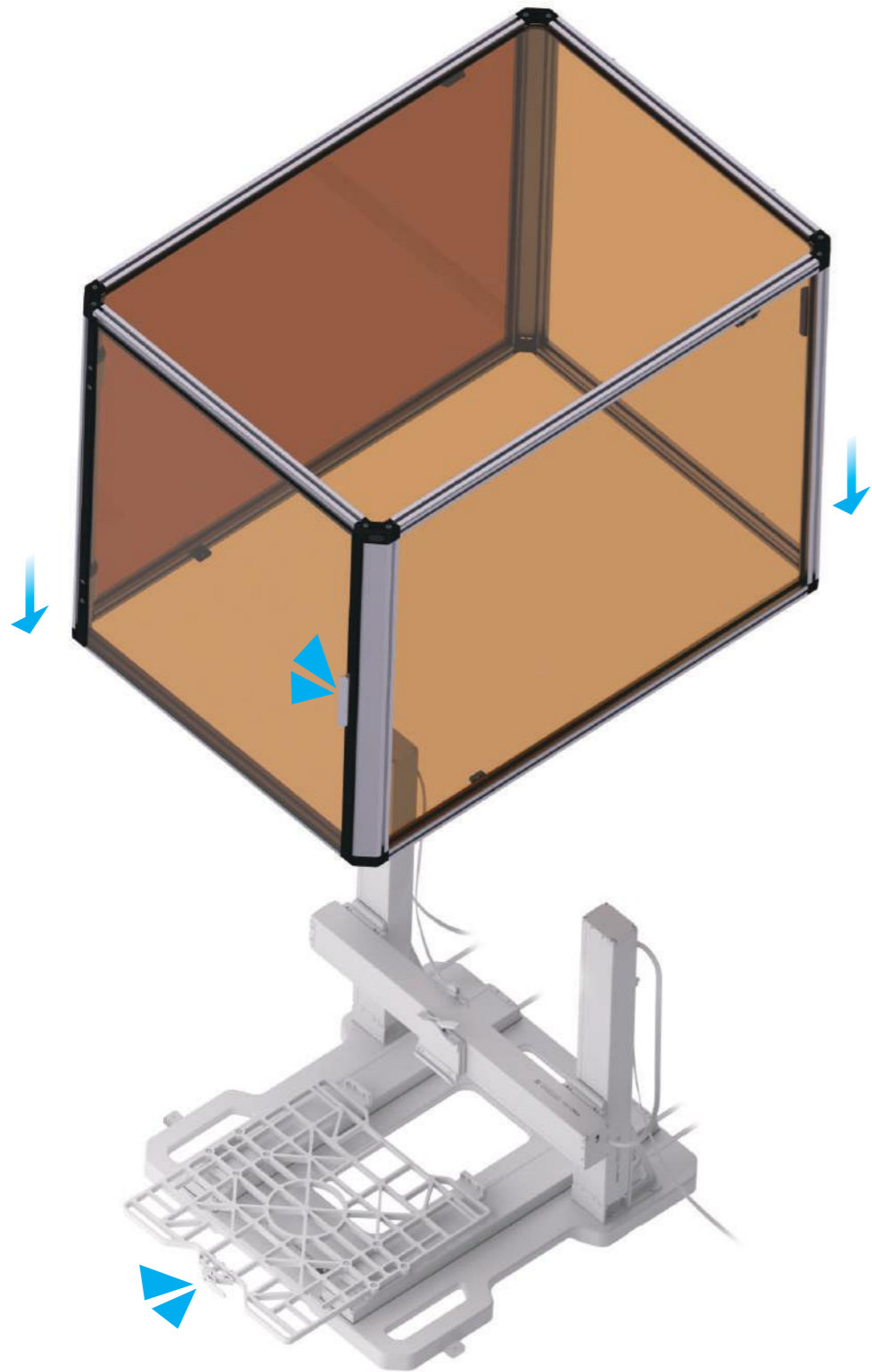

**!** Make sure the Enclosure does not collide with the machine while moving. It is recommended that at least two people operate together.

**19** /28 Plug the Enclosure cable into the Enclosure converter.

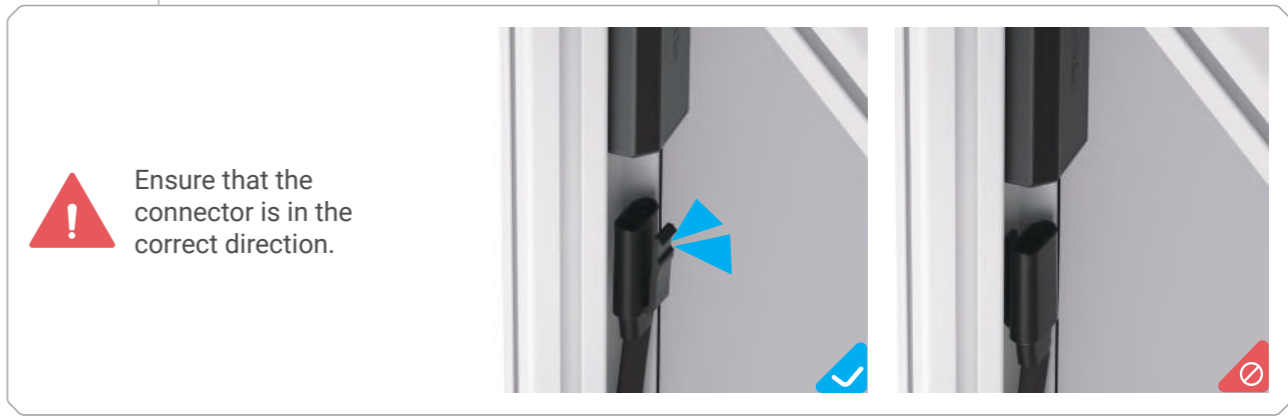

20 /28

Gather the cables with the cable collector.



21 /28

Thread the cables through the corresponding hole of the cable pass-through fixture, and then attach the fixture to the short beam (rear).

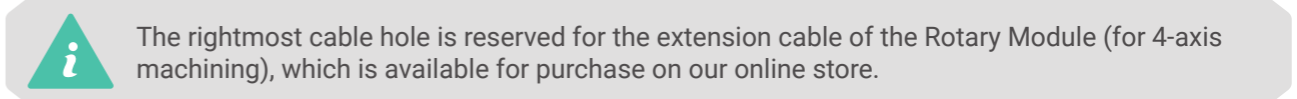
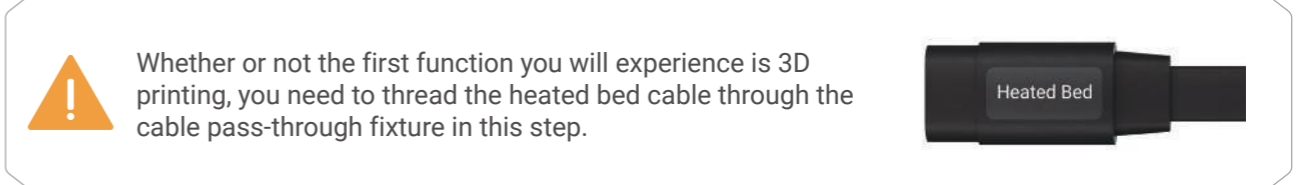
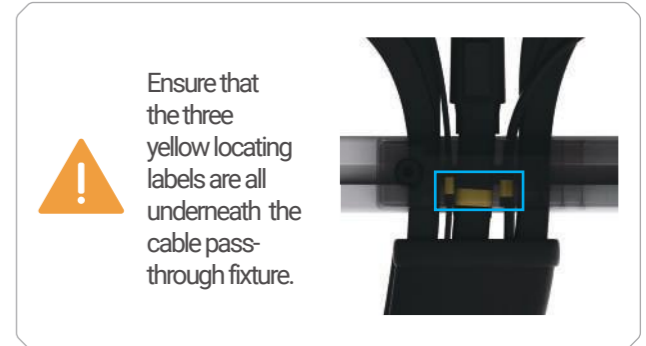
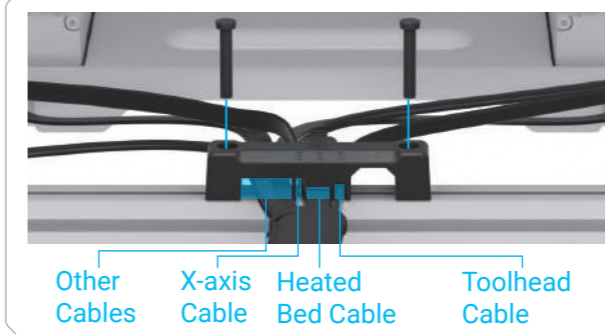
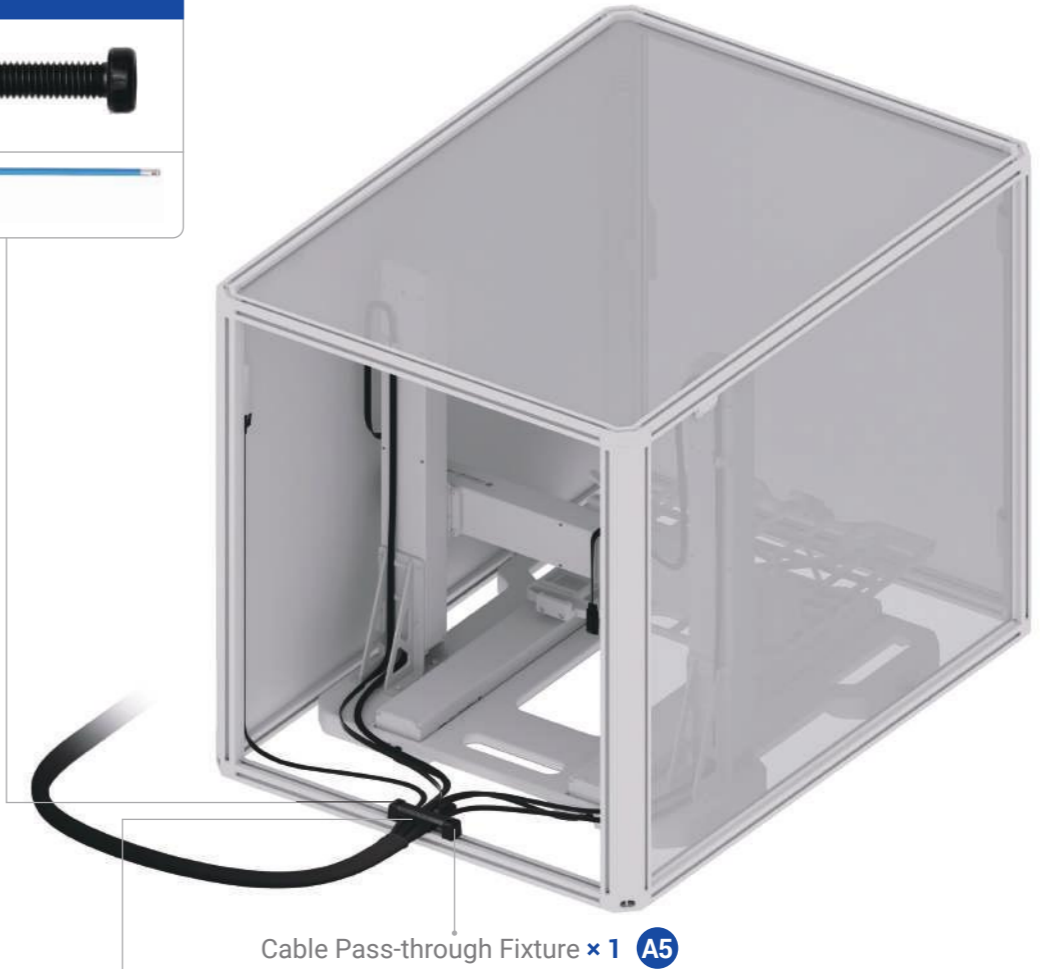
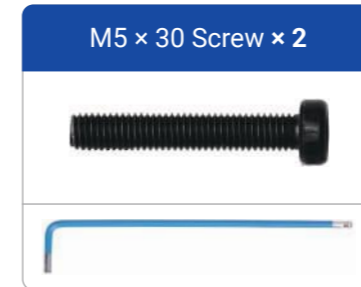

Install the Back Panel and the Exhaust System



Three quarters of the way.

**The destination is in sight!**

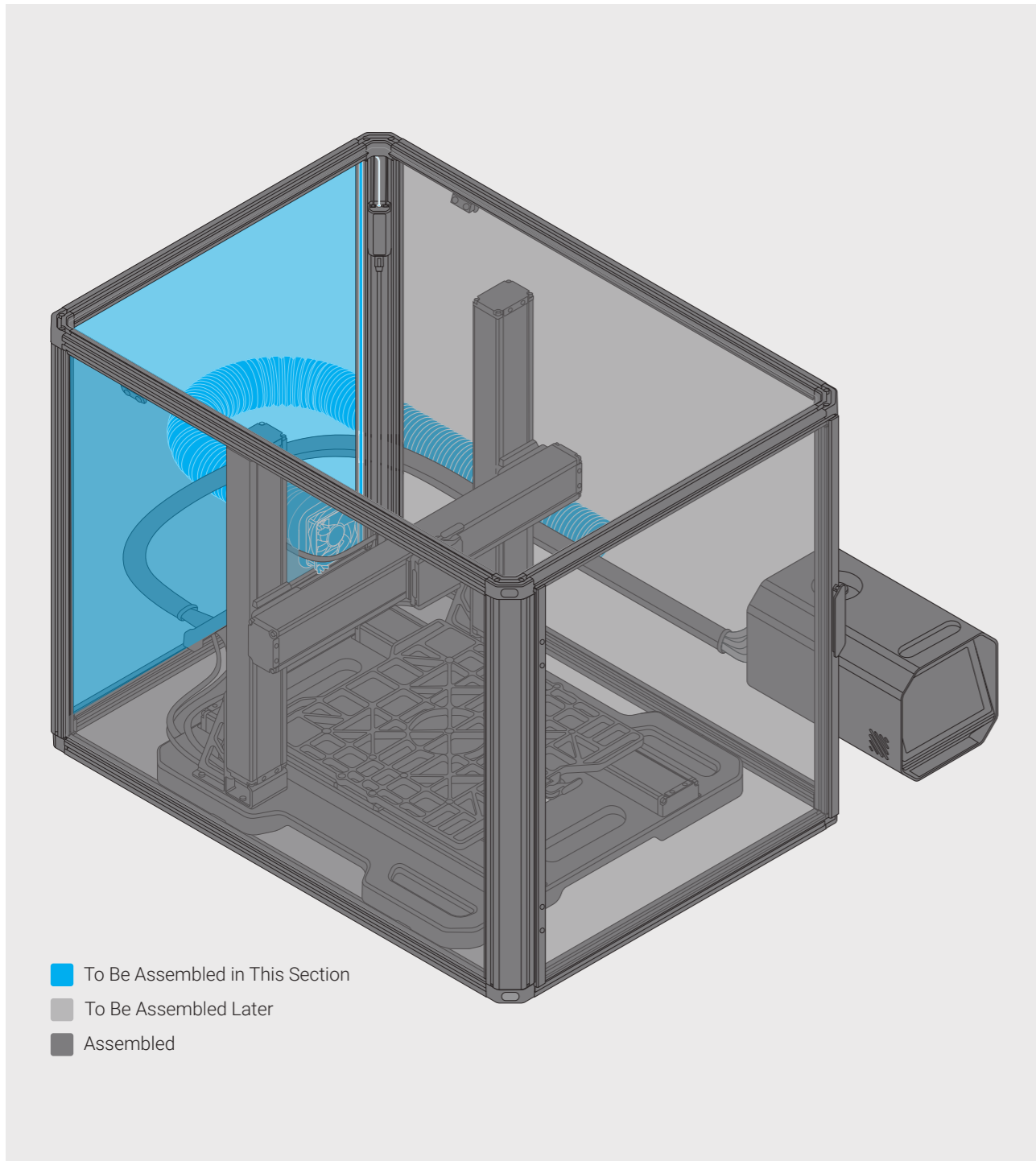

- To Be Assembled in This Section
- To Be Assembled Later
- Assembled

**22** /28

Attach the exhaust fan and the hose connector to the back panel.

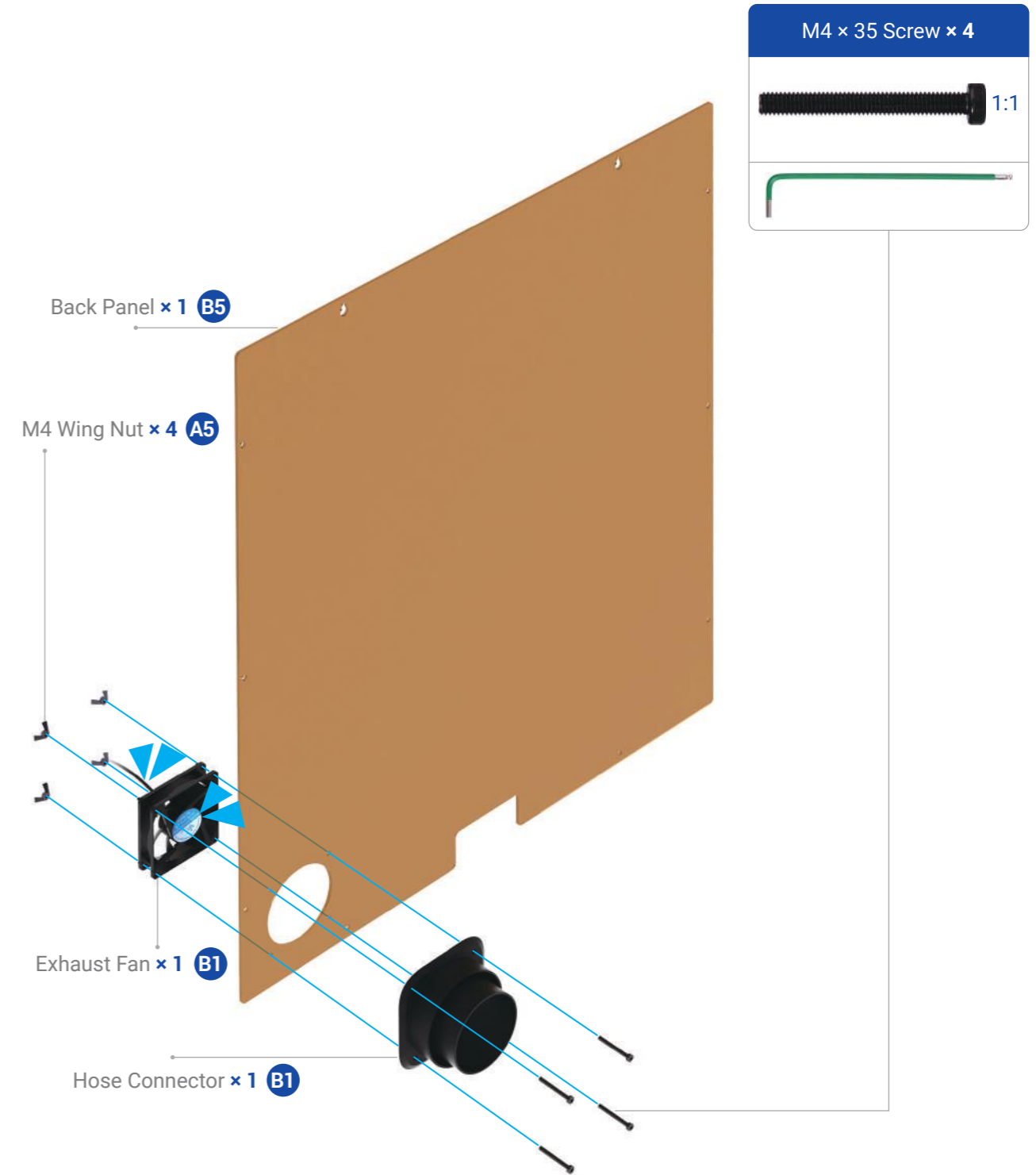



23 /28

Connect the exhaust fan to the Enclosure converter. Then, cut a suitable length of the cord collecting strip to bury the exhaust fan cord into the column groove.

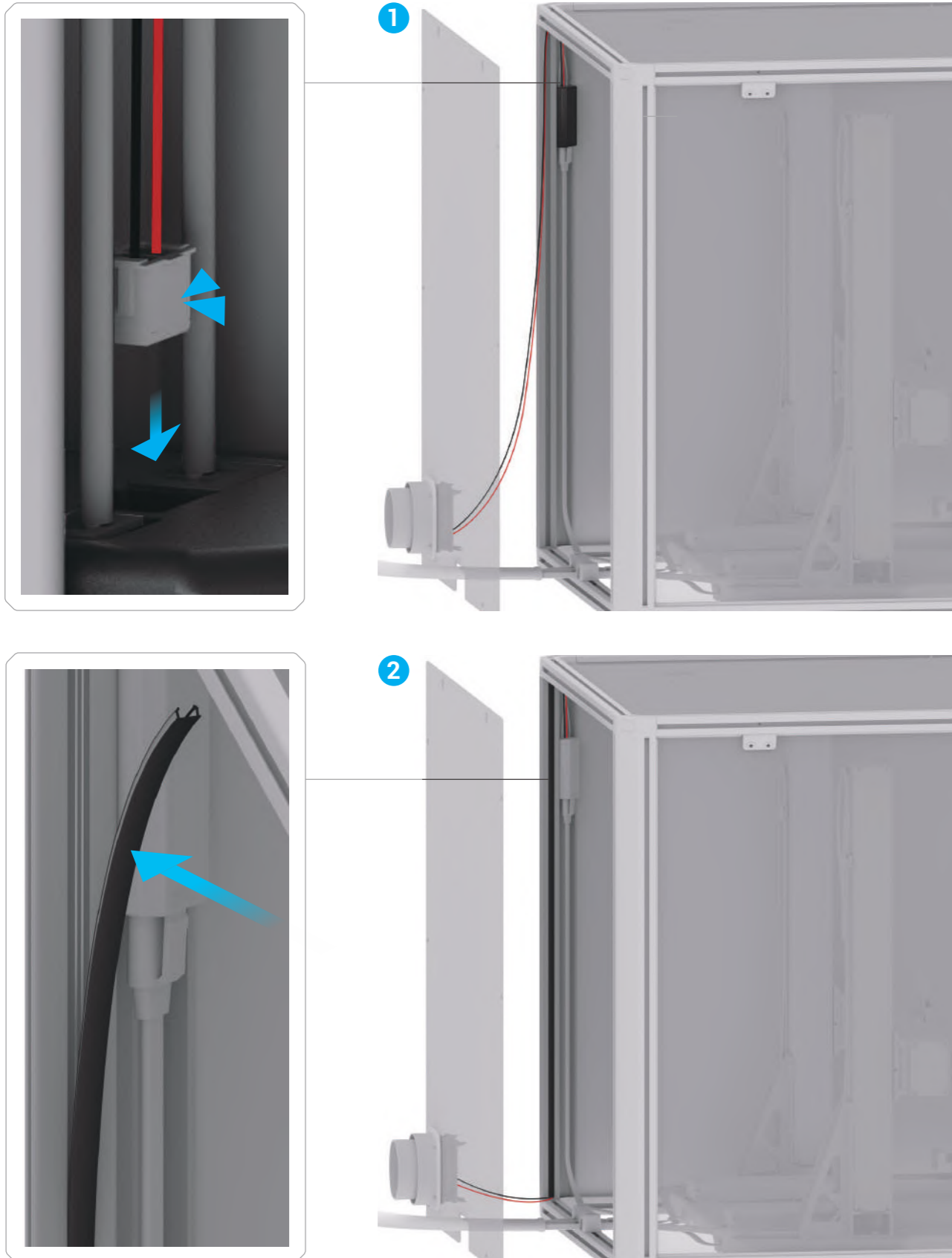

24 /28

Attach the back panel to the frame.

M5 × 16 Low Head Cap Screw × 10

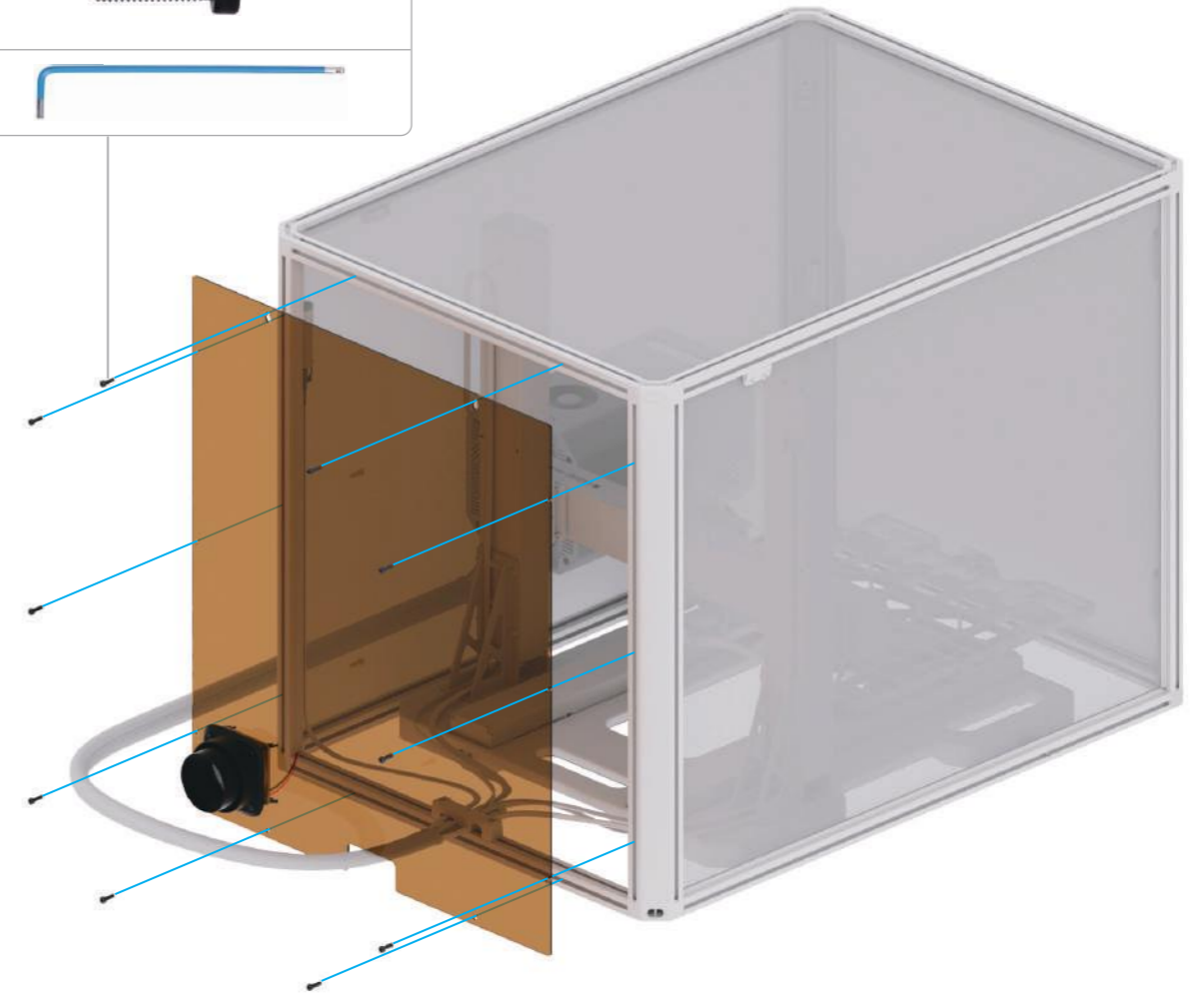

Do not over-tighten the screws lest the panel should be damaged.



It is recommended to pre-tighten the screws near the corners first, then pre-tighten the remaining screws, and finally tighten all the screws in the pre-tightening order.



You can install the two uppermost screws first, hang the back panel on them, and then install the other screws.





25 /28

Put the hose into the hose clamp and secure the hose to the hose connector as illustrated.



Plug, Lock, and Finish

Hang on,  
**It's about to finish!**

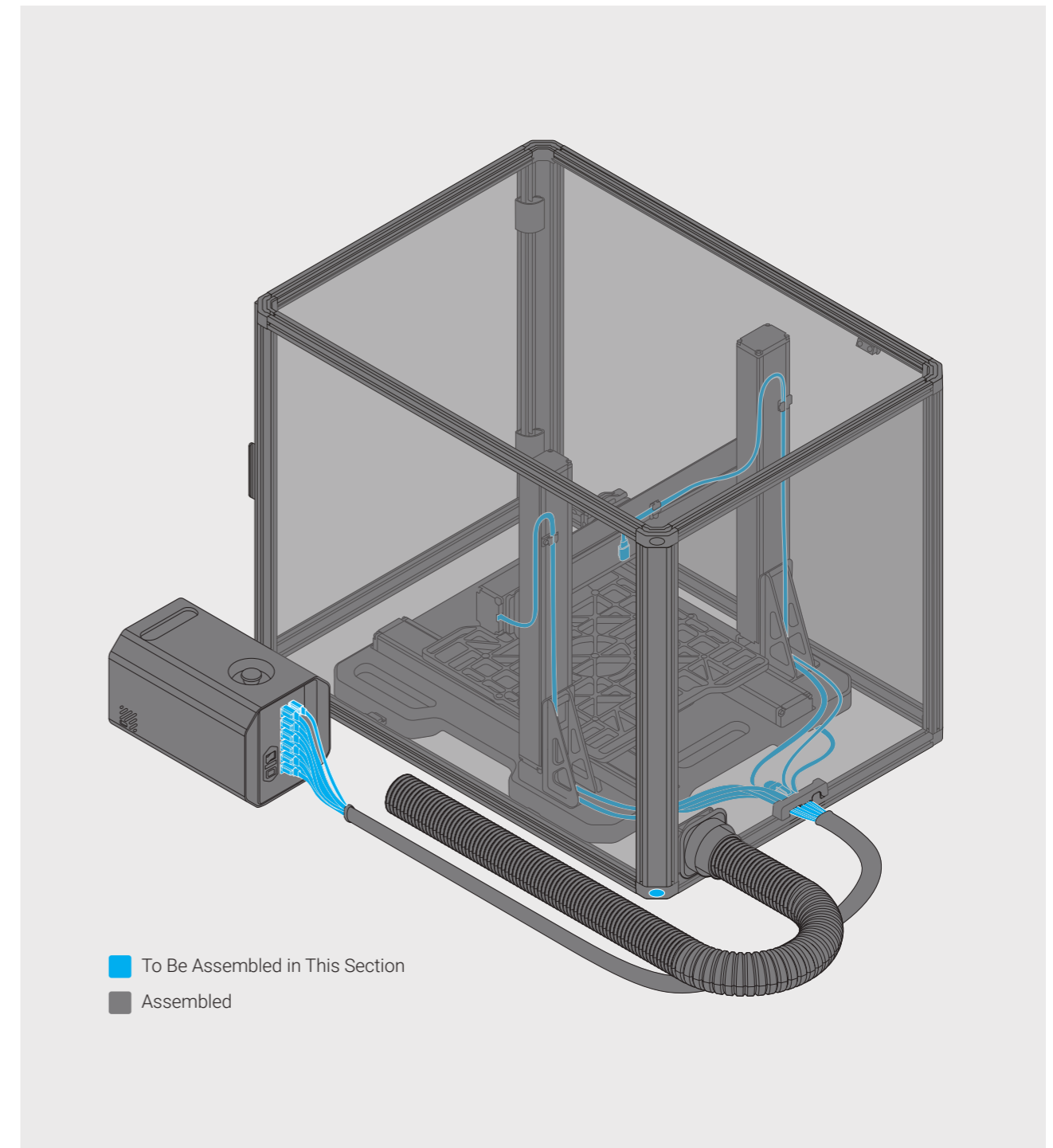

26 /28

Plug the toolhead cable, the Enclosure cable, the heated bed cable, and the Linear Module cables into the Integrated Controller.

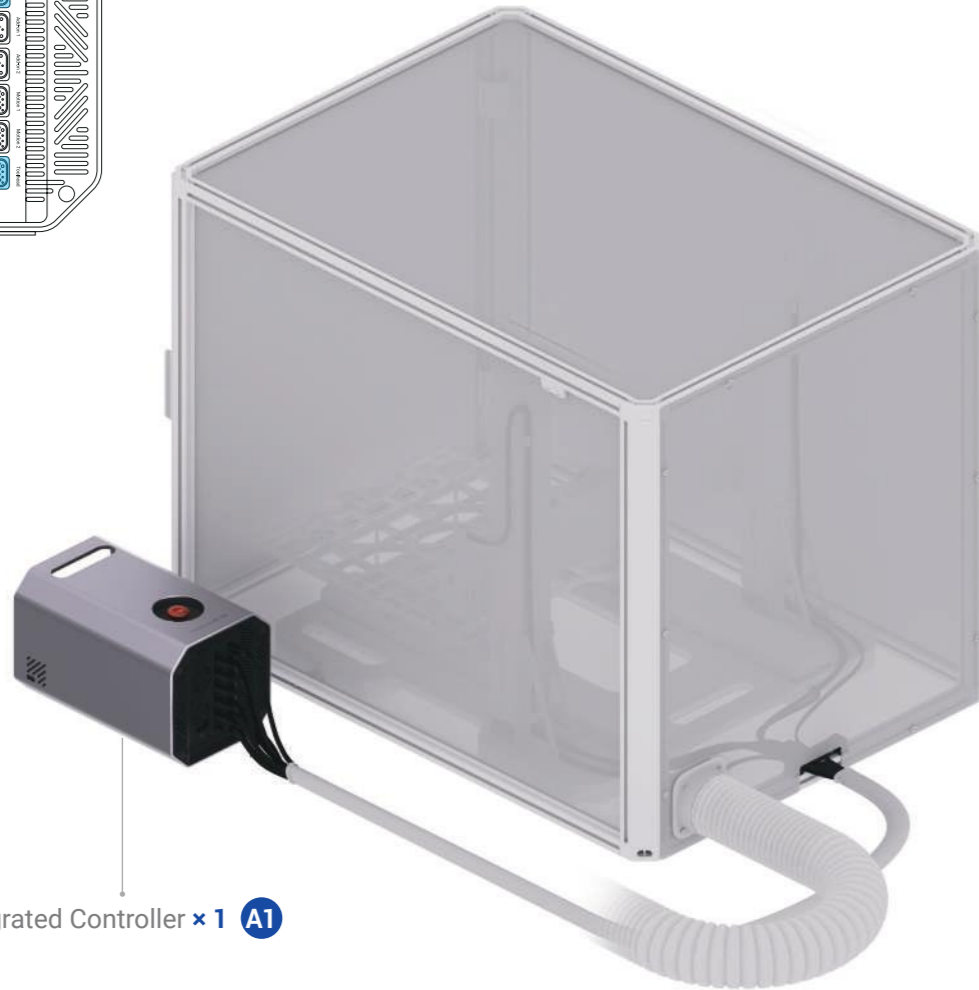
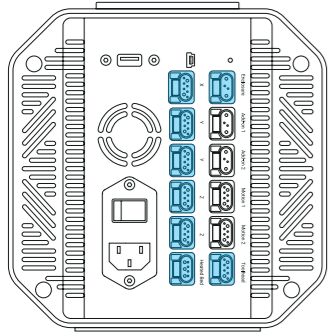

Integrated Controller × 1 A1



Ensure that the connector is in the correct direction.



Place the Integrated Controller within easy reach so that you can press the emergency stop button on top of the controller to respond quickly to an emergency.



It is recommended to place the integrated controller on the right side of the Enclosure to make it easier for you to operate the Touchscreen when the Enclosure door is open.

27 /28

Insert the sealing plugs into the four bottom profile connectors.

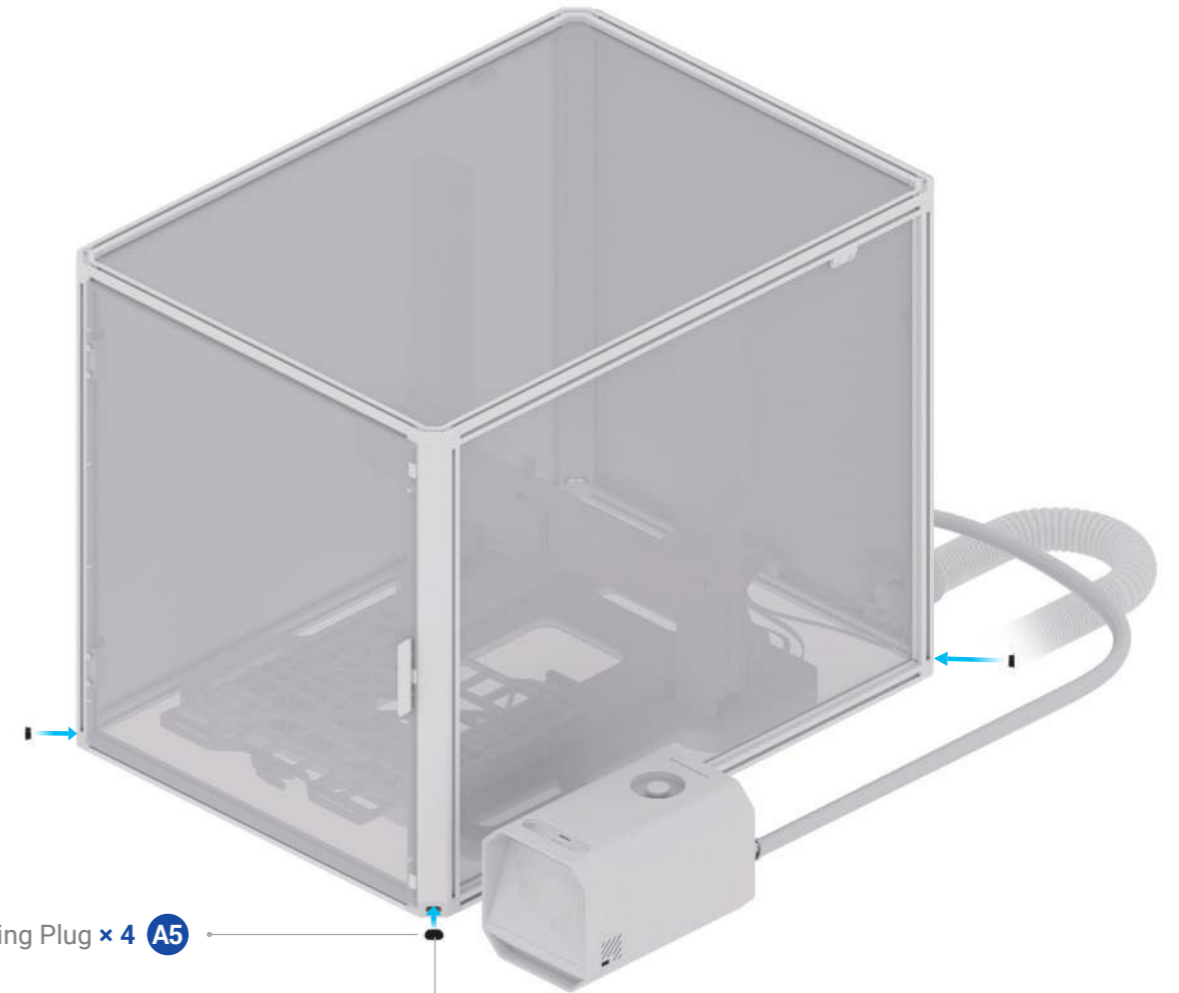

Sealing Plug × 4 A5



28 /28

Connect the upper and lower base fixtures to lock the relative position of the machine and the Enclosure.

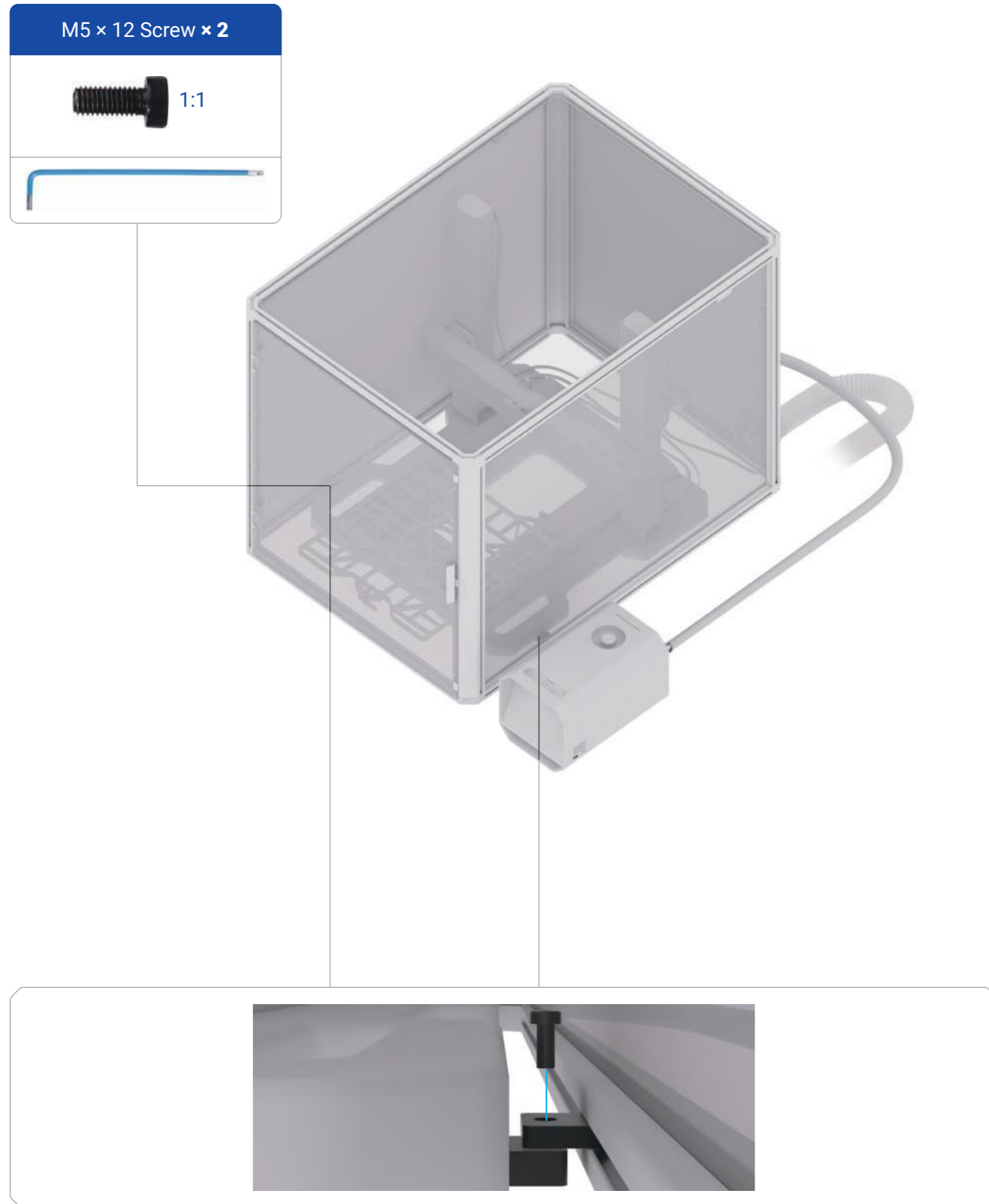

To move the Enclosure and/or the machine, refer to our online User Manual: On the navigation bar of the Snapmaker official website, click **Support > Product Support > Snapmaker Artisan > User Manual**.

## 3.2 Enclosure Settings

### 3.2.1 Enable/Disable Door Detection

The column-2 of the Enclosure features a hall switch to detect whether the door is opened or closed in real time.



You can tap **Settings > Enclosure** to enable or disable Door Detection during a 3D printing or CNC process. During a laser process, Door Detection is enabled by default and cannot be disabled.

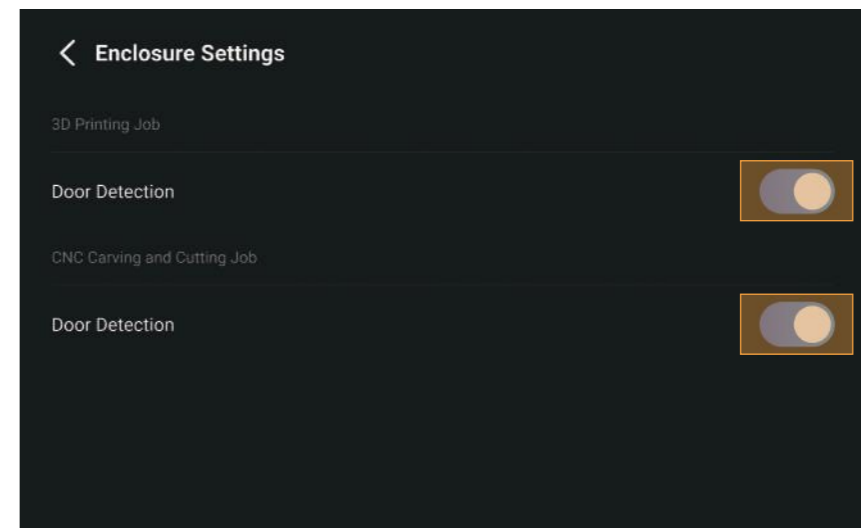

After Door Detection is enabled, the machine will stop operating or end the calibration process immediately whenever the hall switch has detected that the door is opened. To resume operations, you need to close the door first, and then tap  on the Touchscreen to continue the job or restart the calibration process.

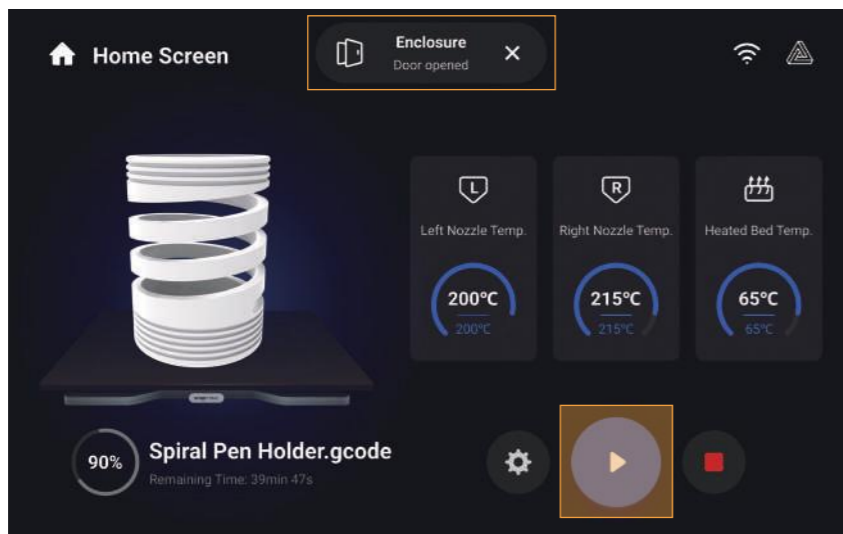
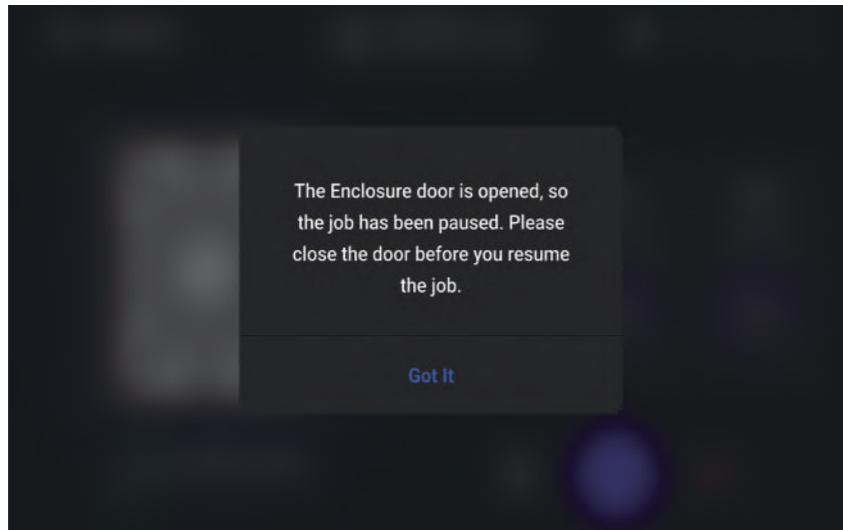

If you need to open the door frequently and do not want the ongoing 3D printing or CNC process to be paused as the door opens, you can disable Door Detection before starting a 3D printing or CNC job.





Whether Door Detection is enabled or not, you must wear the CNC safety goggles before opening the door during a CNC process.



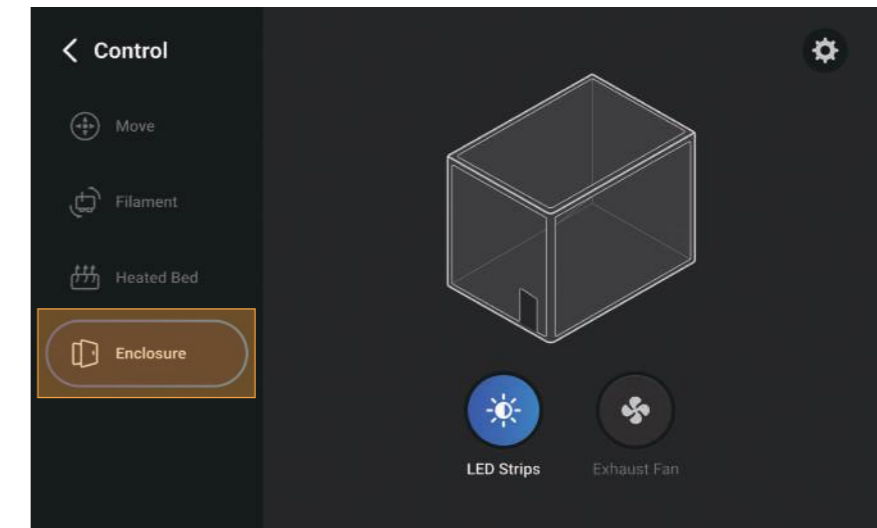

### 3.2.2 Turn On/Off LED Strips and the Exhaust Fan

You can tap **Control** > **Enclosure** to turn on or off the LED strips and the exhaust fan.





You can also tap  to adjust the settings of the LED strips and the exhaust fan during a 3D printing, laser, or CNC process.





For different scenarios, we recommend turning on or off the LED strips and the exhaust fan as shown in the table:

Scenario		LED	Fan
3D Printing	PLA, Breakaway PLA, TPU90, TPU95, High Flow TPU95, TPU-Foam, PVA	O	O
	ABS, PETG, ASA, HIPS, CoPA, PA12-CF, PA6-CF, PA6-GF	O	×
Laser Engraving and Cutting		O	O
CNC Carving and Cutting		O	×

\*O = On   × = Off



Some filaments (such as ABS) may give off odors or fumes during a 3D printing process, while turning on the exhaust fan may affect the printing temperature and therefore impair the print quality. In this case, you can turn on the exhaust fan after printing. To protect your health and prevent environmental pollution, we recommend using Snapmaker Air Purifier or other air purifying devices during such a 3D printing process.

# Absolutely amazing!

You have successfully assembled the machine body and the Enclosure. Now select one function to complete the assembly and create your first masterpiece!

Each toolhead must be used with its corresponding work platform. The mismatch of toolheads and work platforms might result in product damage, property loss, or even personal injuries.



# 110

Laser Engraving  
and Cutting

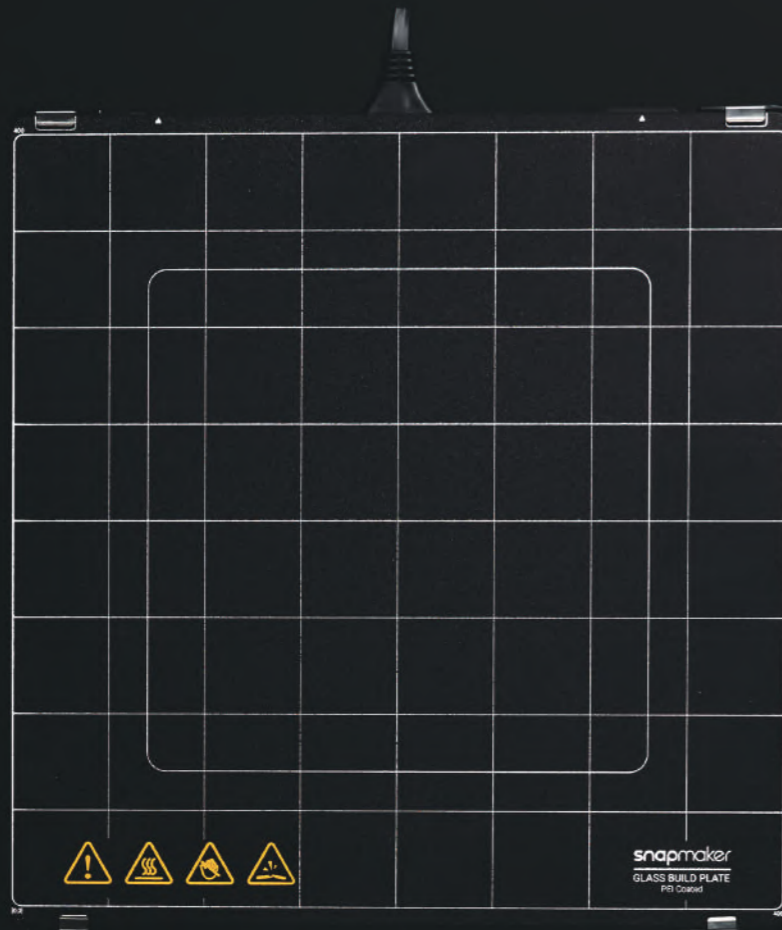

# 86

3D Printing

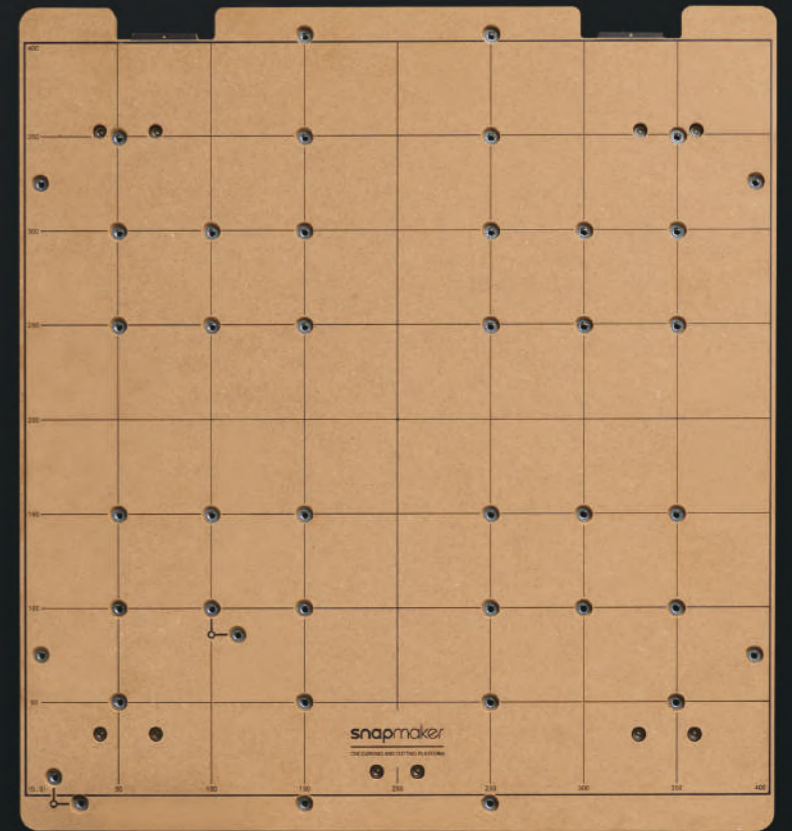

# 132

CNC Carving  
and Cutting

# 3D Printing

## 4.1 3D Printer Assembly

## 4.2 Preparations

- 4.2.1 Set Up the Machine
- 4.2.2 Calibrate the Dual Extrusion Module

## 4.3 Getting Started

- 4.3.1 Install Snapmaker Luban
- 4.3.2 Generate the G-code File
- 4.3.3 Start Your First Print
- 4.3.4 Remove the Print

## 4.1 3D Printer Assembly



01 /10

Loosen the cam handle of the support platform by turning it to the left, and install the 3D printing platform onto the support platform.



Ensure that the PEI-coated side of the glass build plate is facing up, as we will guide you to print Snapmaker Luban's test model with the provided filaments (PLA & Breakaway PLA) in later chapters.

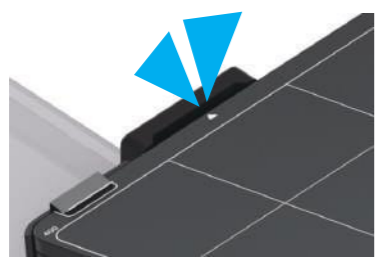
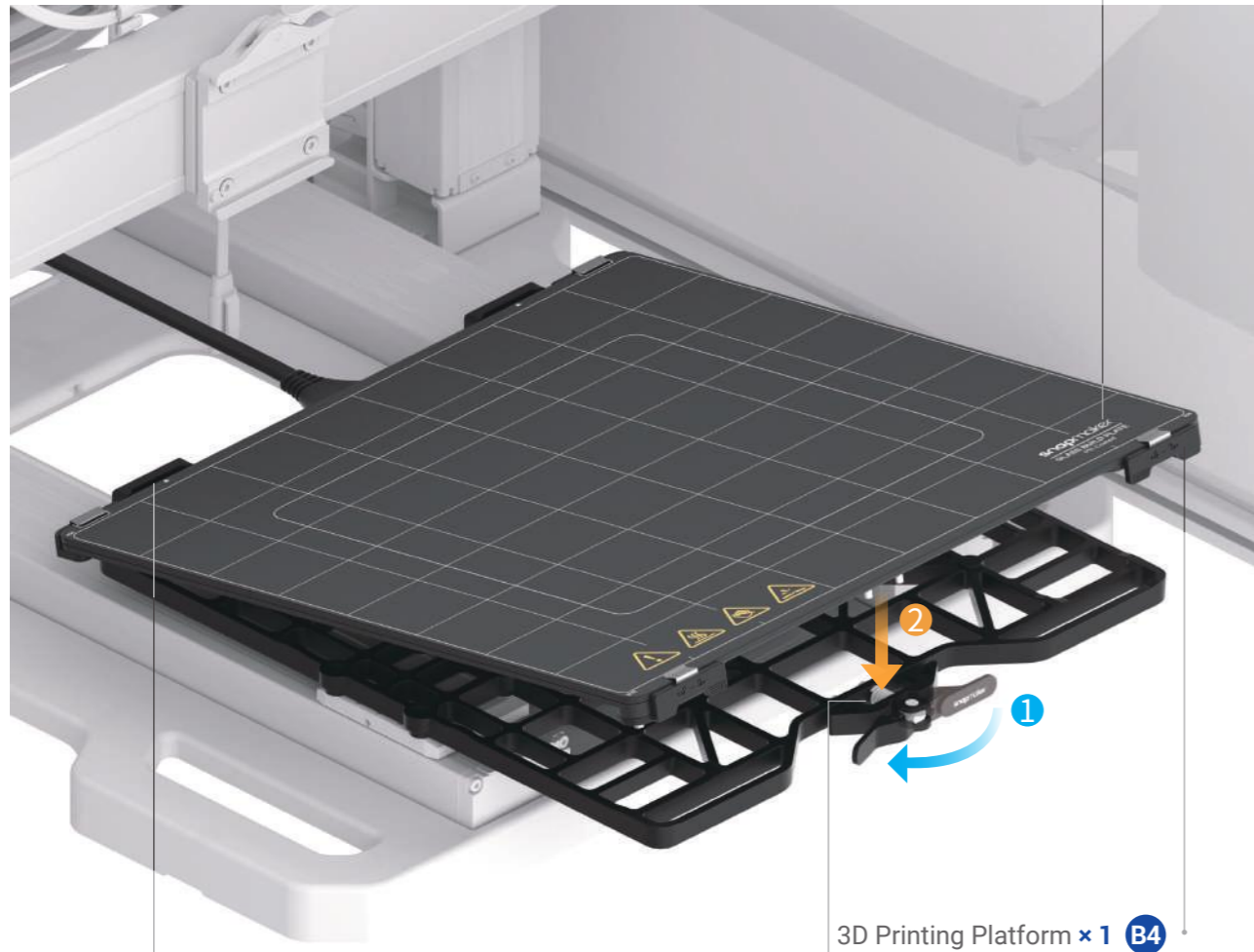

Ensure that the platform is clamped correctly.

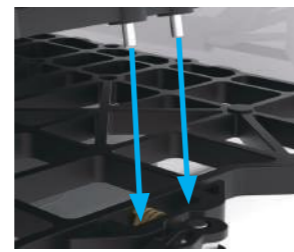

02 /10

Tighten the cam handle of the support platform by turning it to the right.

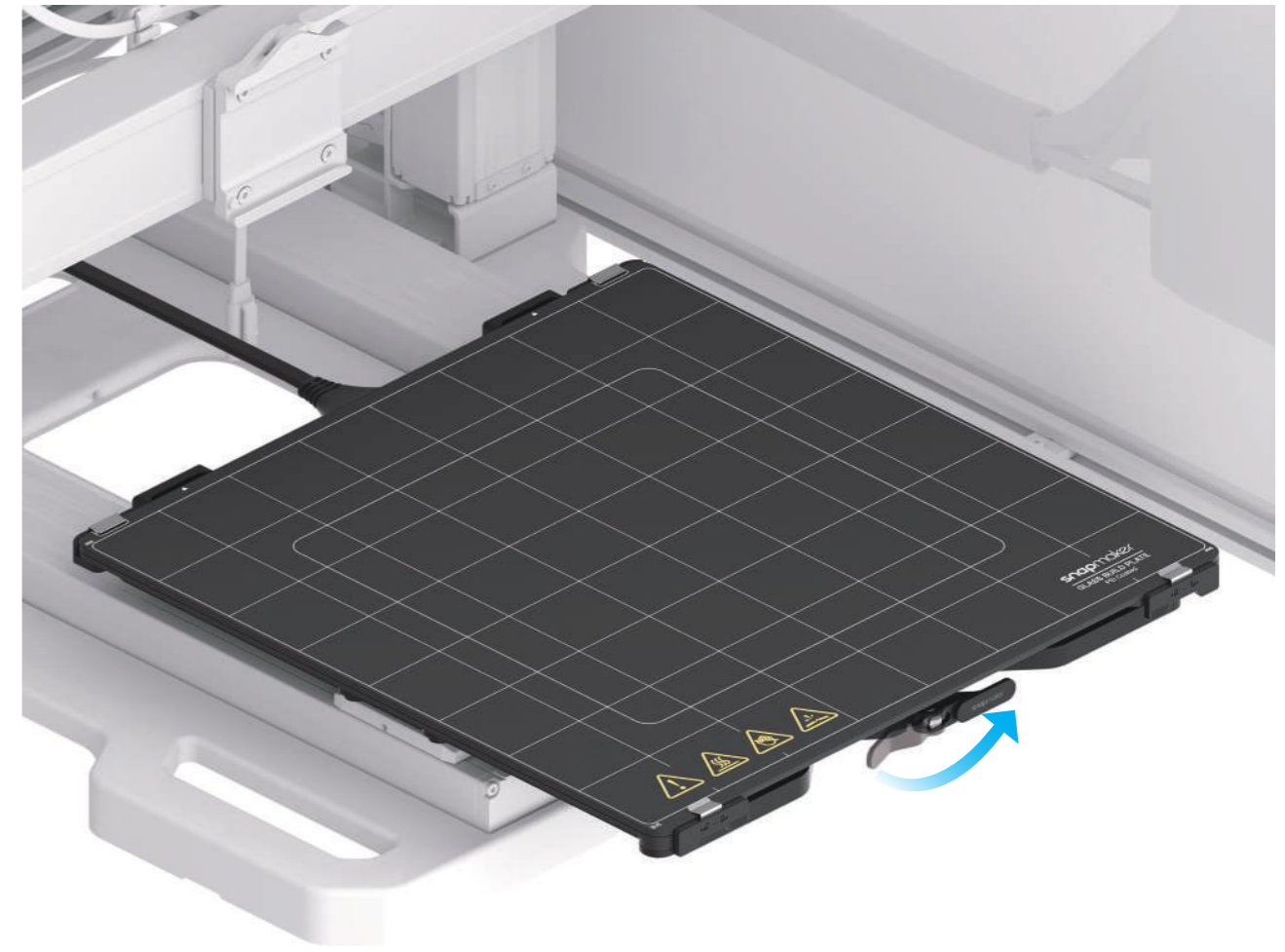



03<sub>/10</sub>

Plug the heated bed cable into the heated bed.

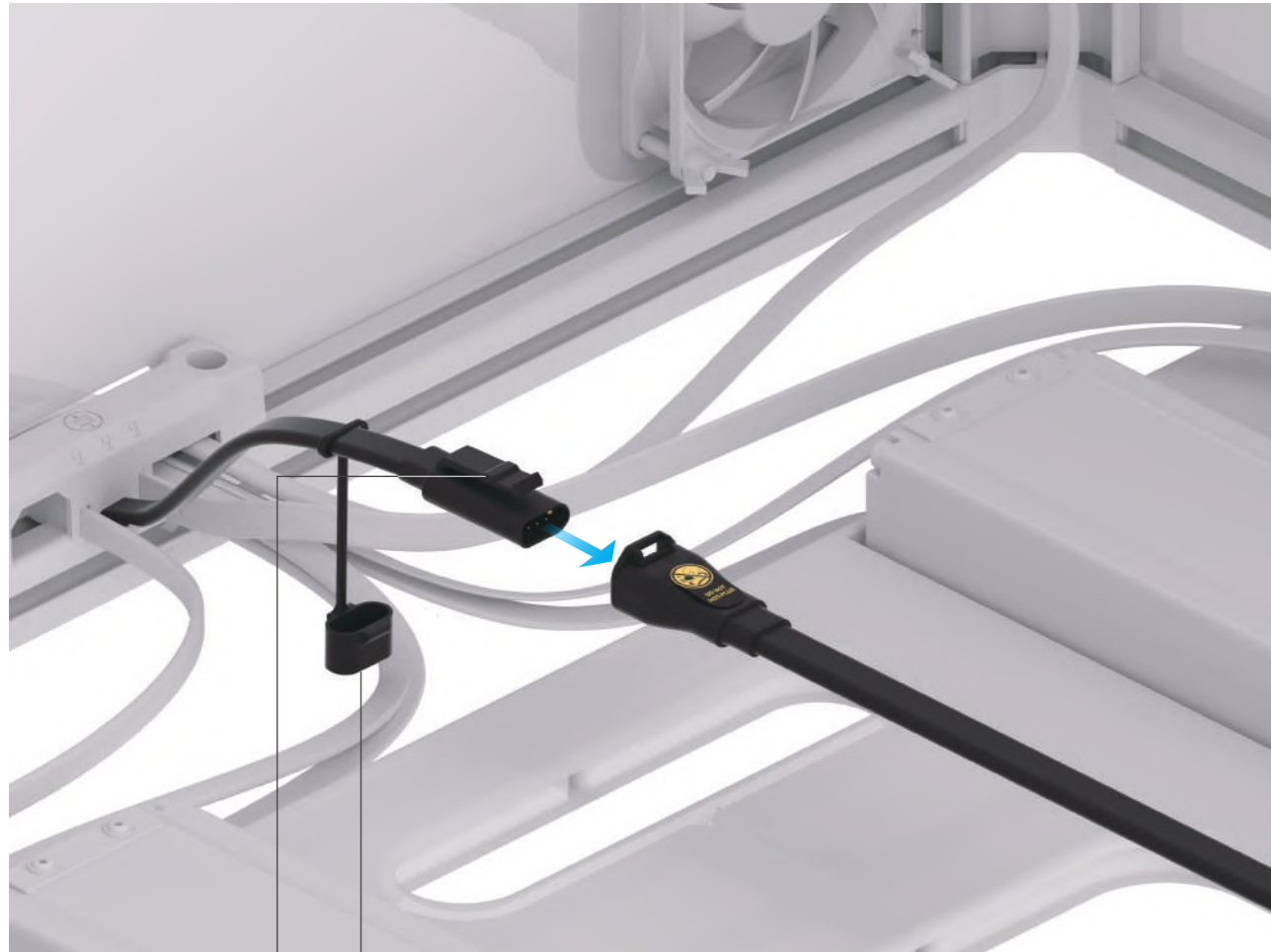

⚠ Ensure that the connector is in the correct direction.

⚠ Keep the dust plug on the connector of the heated bed cable to block material debris during laser or CNC processes.

⚠ Do NOT plug or unplug the heated bed cable when the machine is powered on.

04<sub>/10</sub>

Loosen the cam handle of the toolhead bracket by turning it to the left, and slide the Dual Extrusion Module into the bracket.

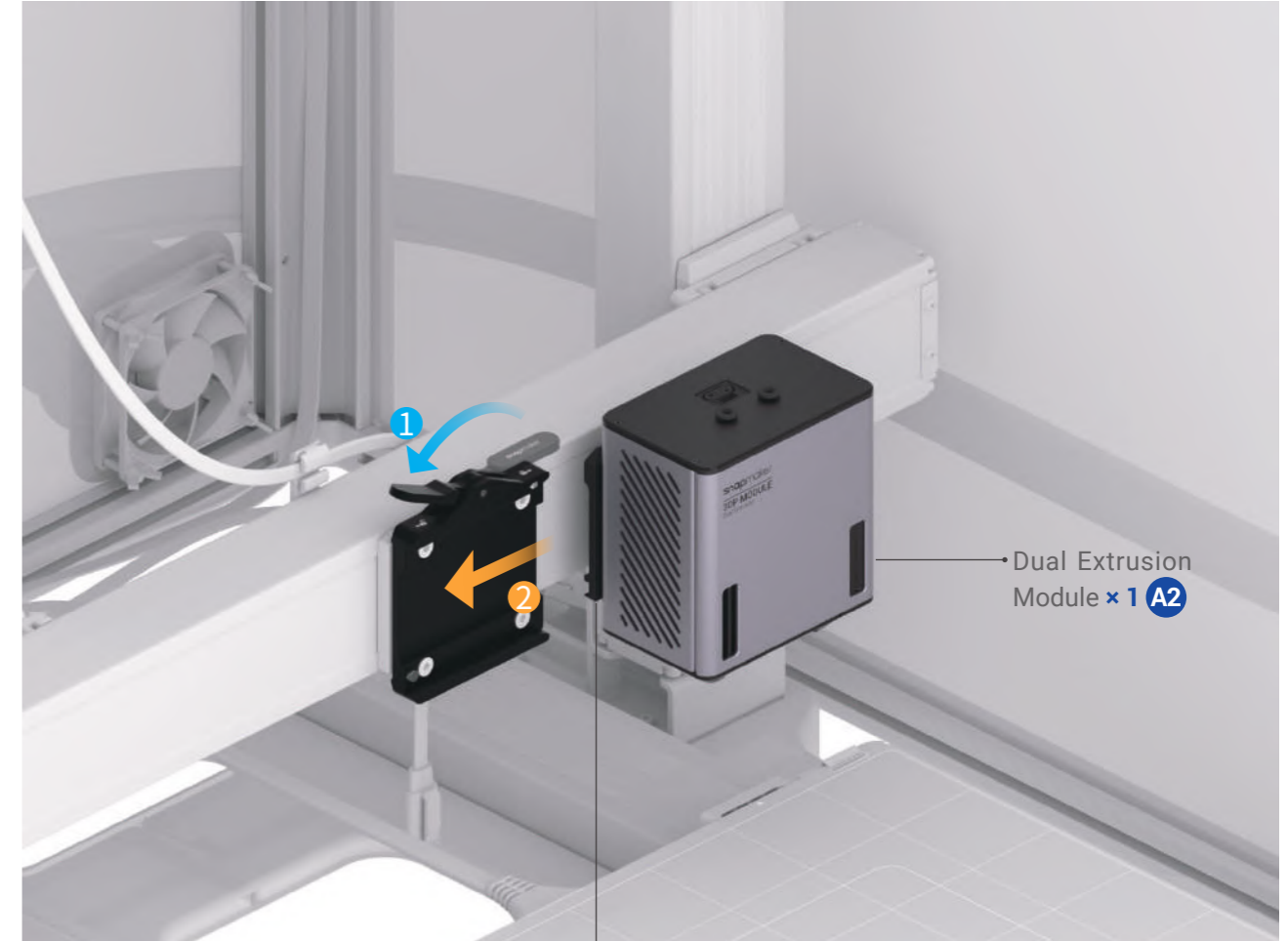

⚠ Make sure to fully slide the toolhead into the bracket.

05<sub>/10</sub>

Tighten the cam handle of the toolhead bracket by turning it to the right.

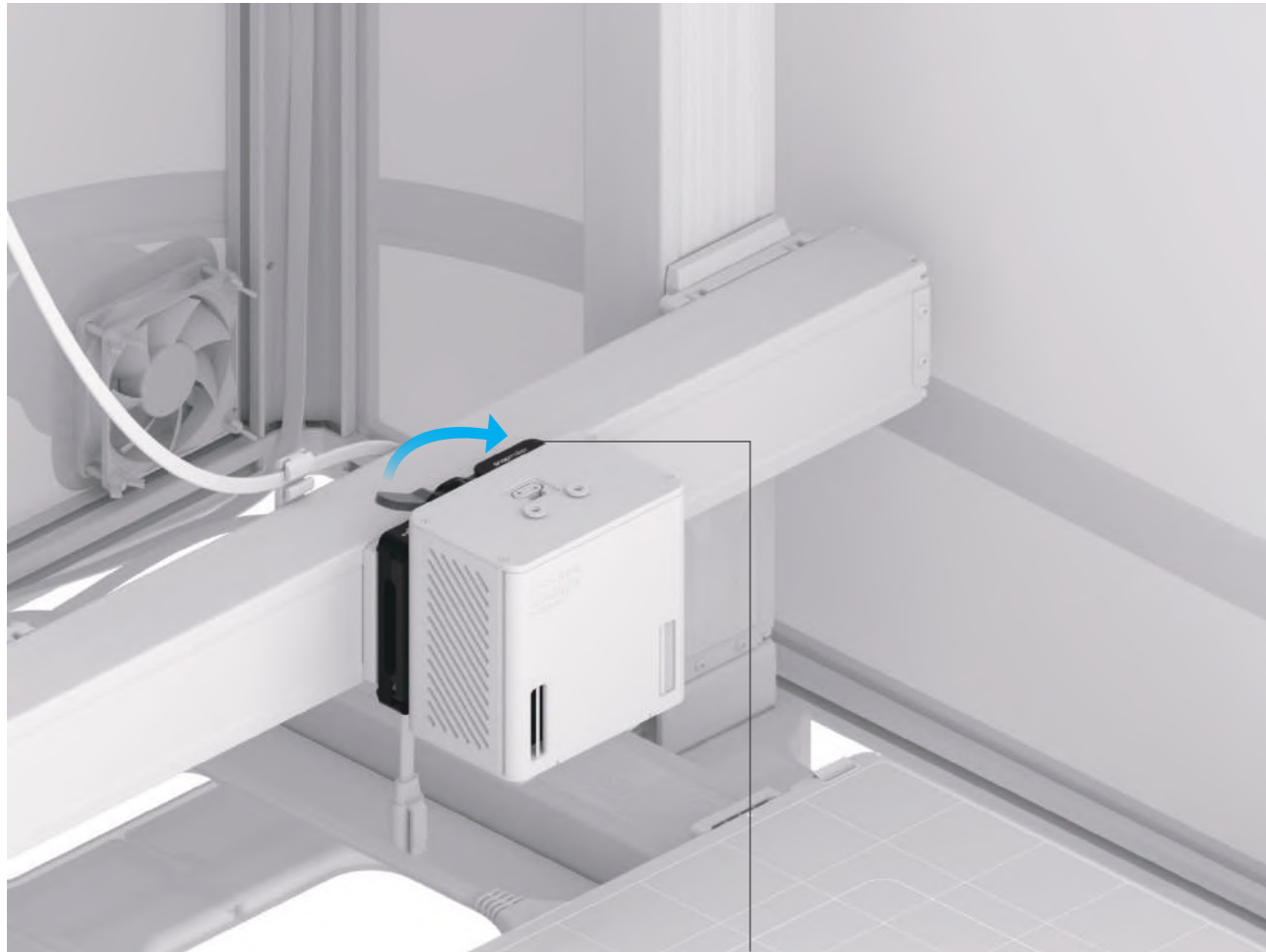

06<sub>/10</sub>

Plug the toolhead cable into the Dual Extrusion Module.

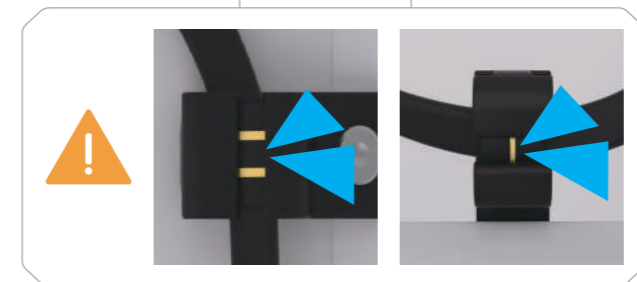
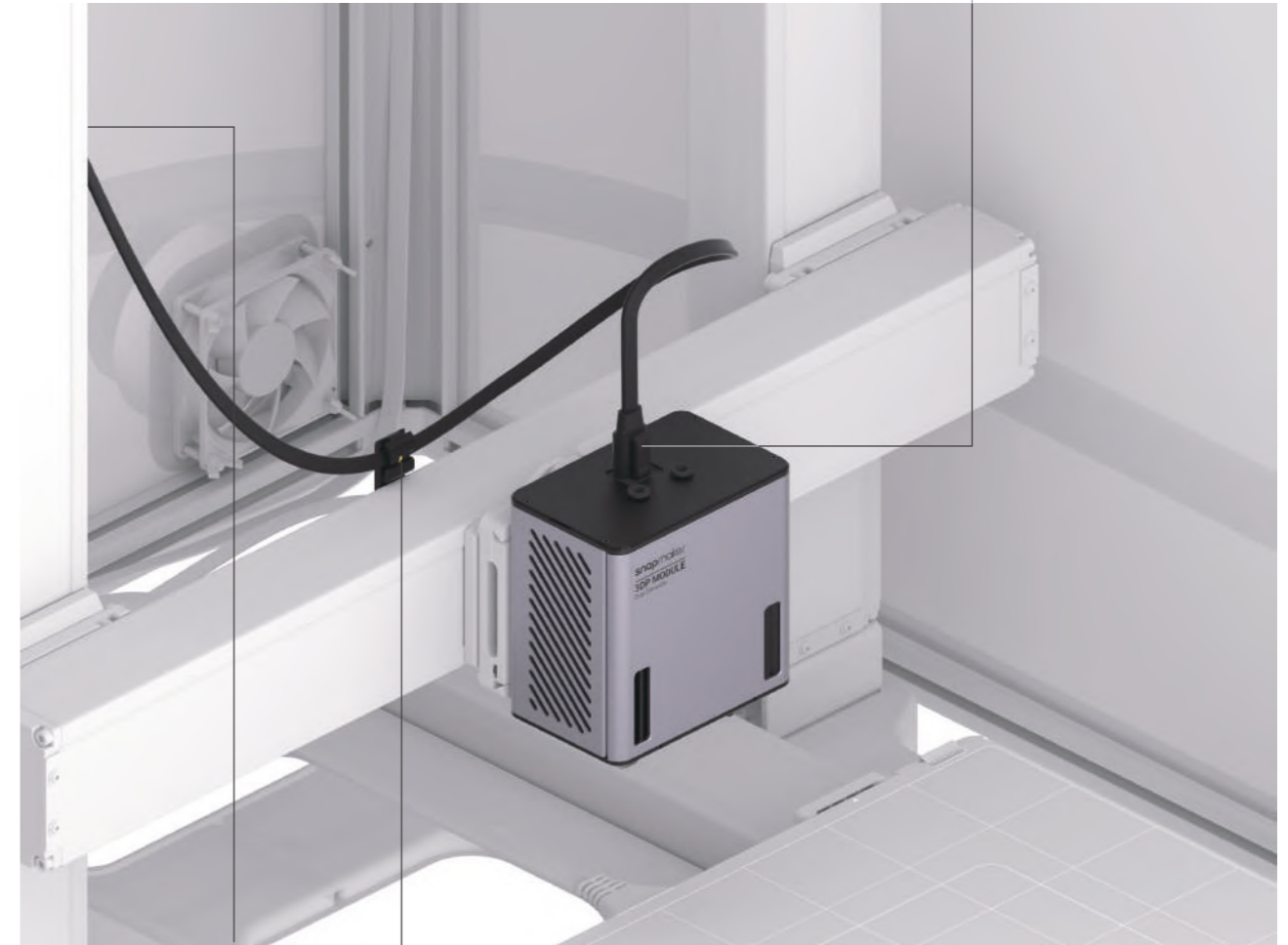

07 /10

Insert the filament tube through the tube holder from the outside in, until the rubber casing of the tube touches the holder.



To pull out the tube, press tight the round clamp at the outer hole while pulling.

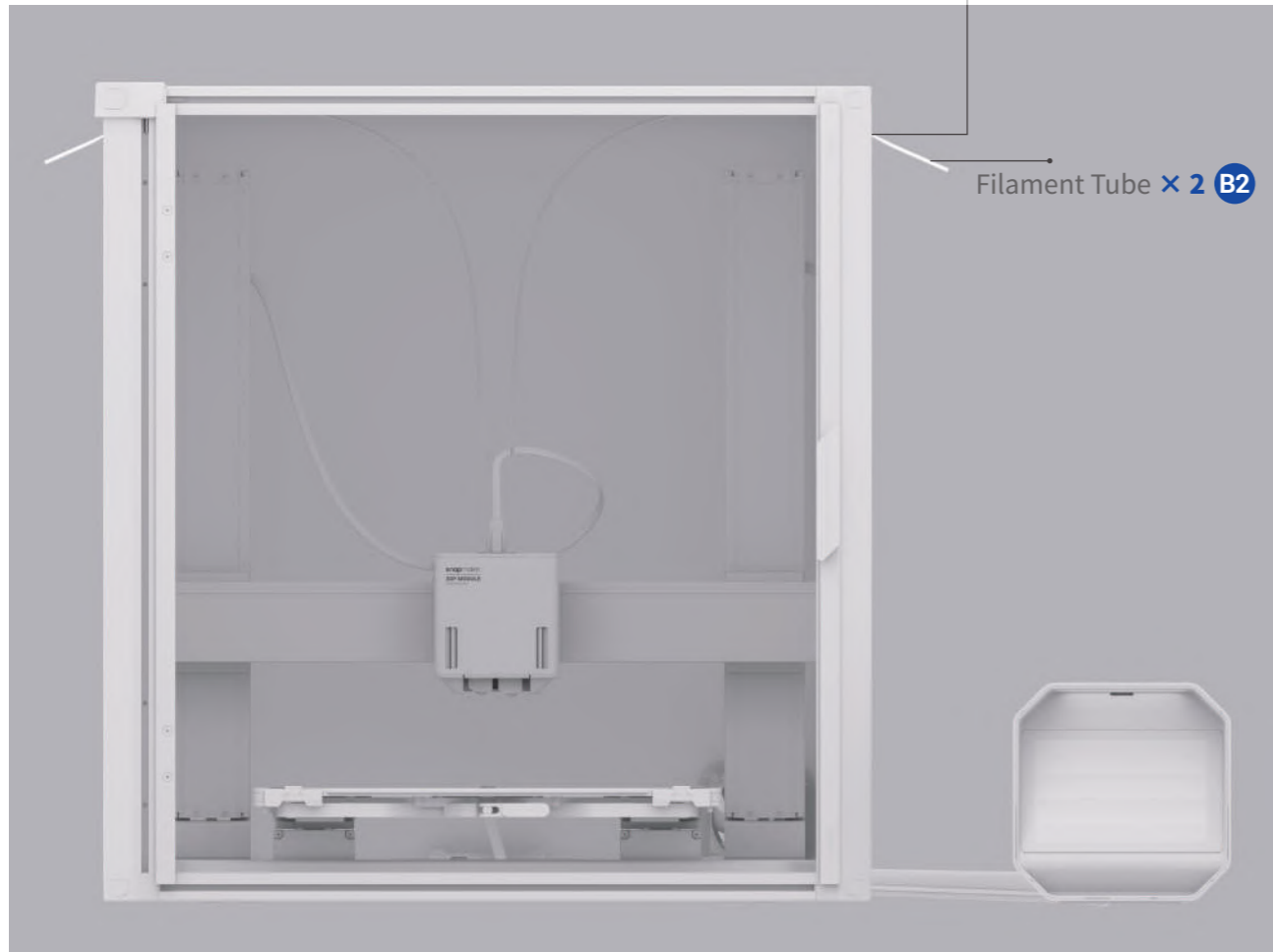

Before laser or CNC processes, you need to stick the provided tube clips to the illustrated position inside the Enclosure and press the filament tube into the clip.

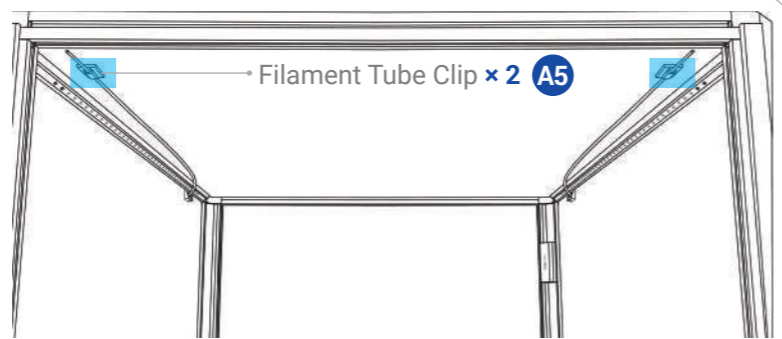

08 /10

Remove the tube fixture from the filament entry, insert the filament tube into the module, and finally attach the tube fixture back.

1

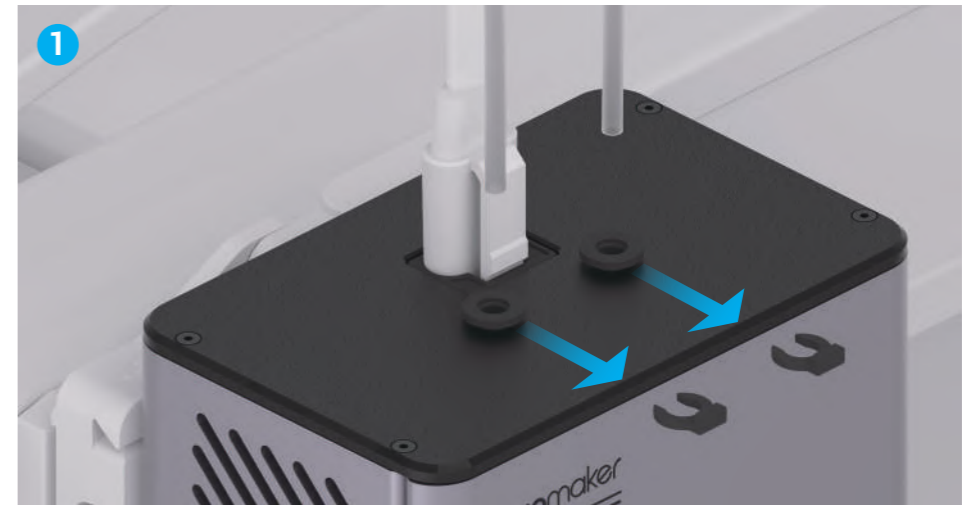

2



3



To pull out the filament tube from the module, remove the tube fixture first and press tight the round clamp at the filament entry while pulling.

**09**<sub>/10</sub> Attach the filament holder to the Enclosure.

**M5 × 12 Screw × 2**

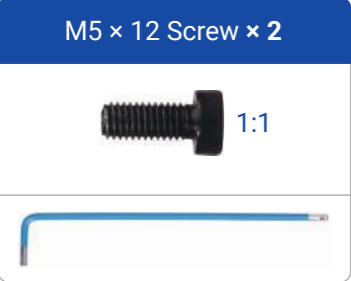

1:1

**M4 × 20 Screw × 4**

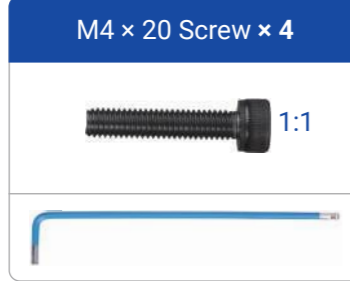

1:1





Left Filament Holder Base × 1 **A5**

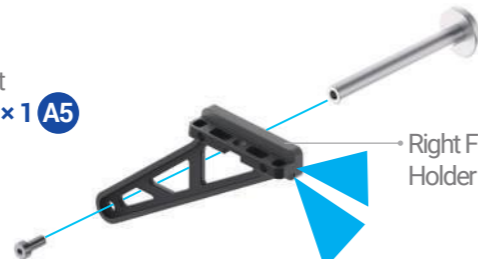



Right Filament Holder Base × 1 **A5**

Filament Holder Tube × 2 **A5**

**10**<sub>/10</sub> Plug the AC power cable into the Integrated Controller and the electric outlet.

 Before plugging, ensure that the power switch is OFF.



 Do NOT plug or unplug any cables when the machine is powered on.





AC Power Cable × 1 **A6**



**Congrats! You have completed the assembly.**

Tear off the base plate sticker and start to make something wonderful with Snapmaker!

MAKE SOMETHING WONDERFUL

## 4.2 Preparations

### 4.2.1 Set Up the Machine

1. Turn on the power switch on the back of the Integrated Controller.



To restart your machine, wait for at least 5 seconds after power-off.

2. Follow the on-screen instructions to set up the machine: Read the **Terms and Conditions** > Choose the language > Name the machine > Connect to a Wi-Fi network.

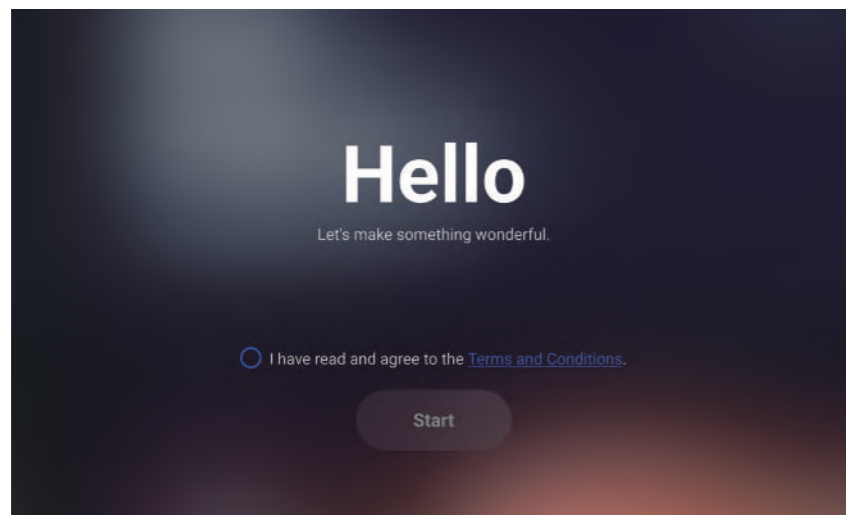

This initial setup wizard appears only the first time you turn on the machine. To change these settings later, tap **Settings** on the Home Screen and select **Wi-Fi**, **Language**, or **About Machine**.

### 4.2.2 Calibrate the Dual Extrusion Module

For the first-time use of the 3D printing function, the Touchscreen will walk you through the necessary calibration processes so that the Dual Extrusion 3D Printing Module can work properly.

You will have to complete three processes following the calibration wizard: Load Filament, Z Offset Calibration & Heated Bed Leveling, and XY Offset Calibration. Before you start the calibration, we recommend that you read this section to learn about each process.

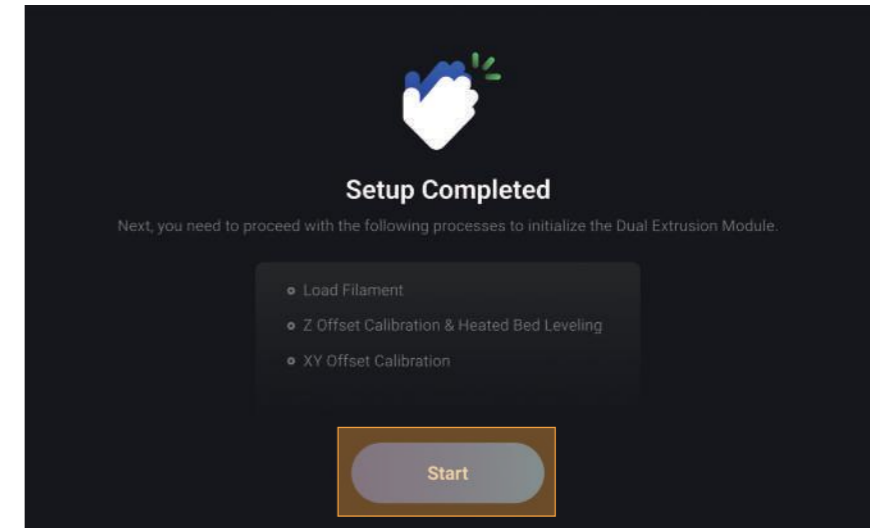



This calibration wizard appears only the first time you use the Dual Extrusion Module. To redo the calibrations later, tap **Calibration** on the Home Screen and select the corresponding process.

#### 1. Load Filament

The filament is fed into the module via the filament entry, passed by the extruder to the hot end, and extruded out of the nozzle after being heated. Our Dual Extrusion Module adopts the design of the dual-gear extruder, which features better extruding force, achieves stable and smooth loading and unloading, and can effectively avoid filament break and nozzle jam.



 Make sure to load the provided black PLA filament into the left nozzle and the white Breakaway PLA filament into the right nozzle, which is required to print the test model of Snapmaker Luban in later sections.

 If the filament has a bent or curled end, cut it off before loading.

 Do NOT touch the nozzle with bare hands during the filament loading process, as the nozzle will be heated to an extremely high temperature.

 To change the filament later, take the following steps:  
 1. Tap **Control > Filament**.  
 2. Select the target nozzle, set the temperature, and tap **Heat**.  
 3. When the heating completes, tap **Unload** and pull the filament out of the nozzle.  
 4. Insert the new filament into the module, and tap **Load** until the new filament extrudes successfully.

## 2. Z Offset Calibration & Heated Bed Leveling

### Brief Introduction

The Dual Extrusion Module features a smart sensor that can be used to automatically level the build plate and adjust the distance between the two nozzles and the build plate. In this way, the machine ensures both nozzles always extrude at a proper and consistent height throughout the printing process to avoid poor first-layer adhesion, build plate abrasion, and collision.

### How It Works

In the Z Offset Calibration, the two nozzles will move in turn to obtain the Z-axis height of the module when the nozzle just touch the build plate. In the subsequent Heated Bed Leveling process, the left nozzle will repeat the above steps at specific points on the build plate to obtain the whole flatness data. With the collected data, the machine will make real-time compensation for the build plate undulations by adjusting the Z-axis movements of the module during printing.

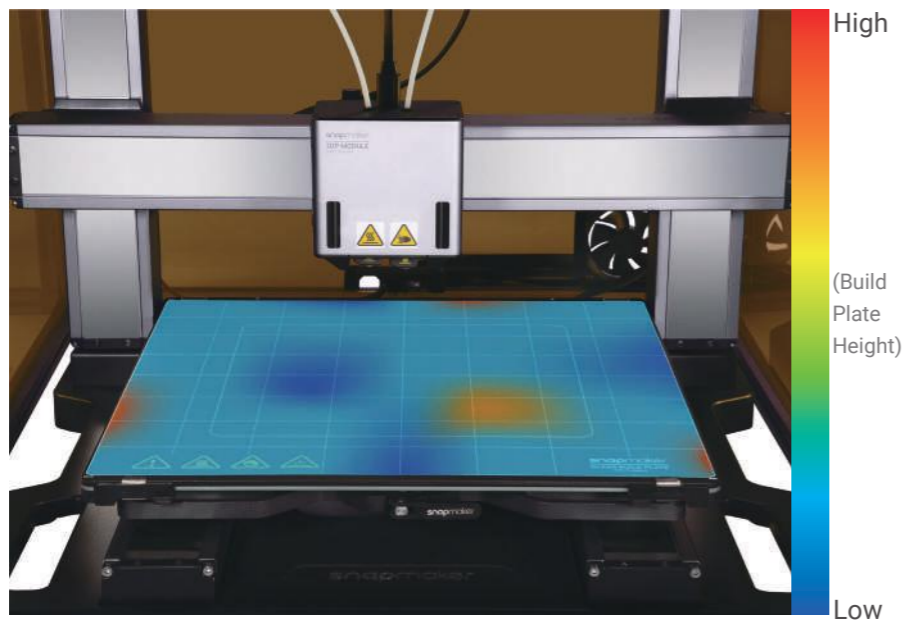

 Before doing the Z Offset Calibration and the Heated Bed Leveling, ensure that the surface of both nozzles is clean.

 Every time after you have reassembled the module or machine, redo the Z Offset Calibration and Heated Bed Leveling: tap **Calibration** on the Home Screen > **Z Offset Calibration** or **Heated Bed Leveling**.  
 Every time after you have replaced the hot end, you only need to redo the Z Offset Calibration.

## 3. XY Offset Calibration

### Brief Introduction

Calibrating the offsets of the two nozzles in the X and Y orientations can achieve the optimal print quality of both nozzles in the horizontal direction and avoid crossovers between different colors and materials.

### How It Works

The machine will print a calibration model in the X and Y orientations, respectively. After you have selected the best pair of lines (where the top line is most horizontally centered on the bottom line) in the two models, the machine will automatically calibrate the X and Y offsets of the two nozzles accordingly by making real-time compensation.

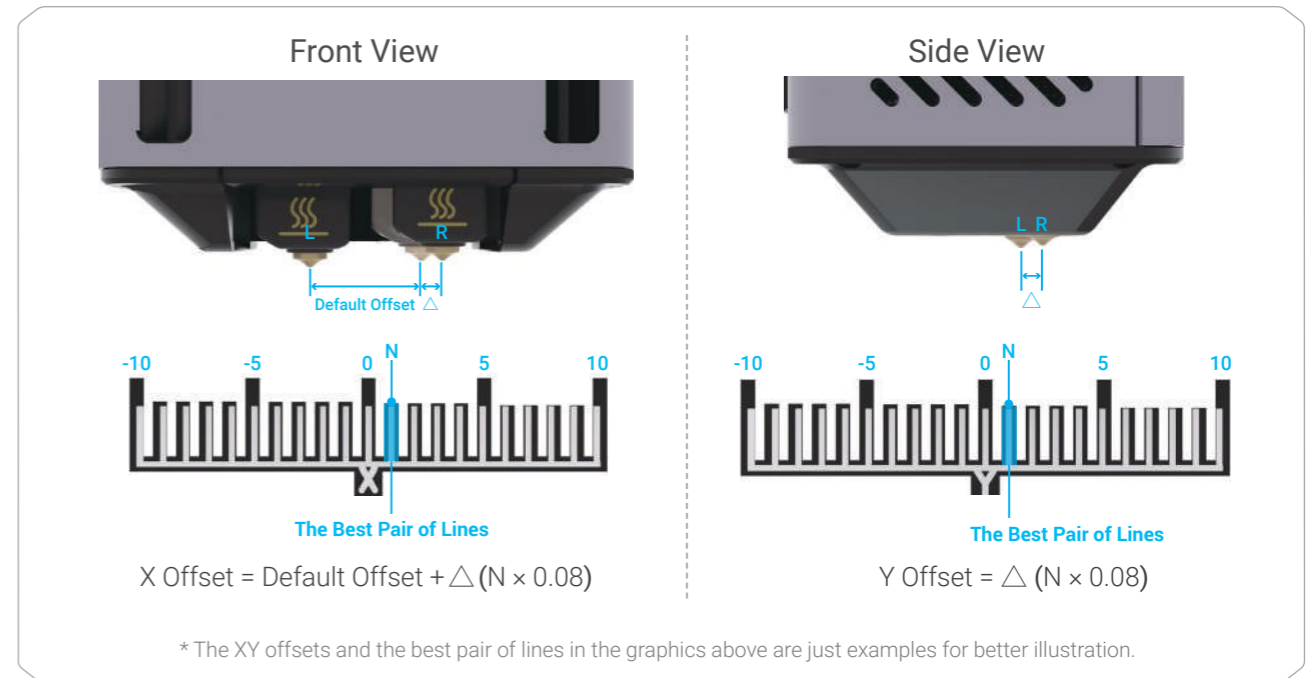



Before doing the XY Offset Calibration, ensure that the glass build plate is clean.



Every time after you have replaced the hot end, you need to redo the XY Offset Calibration: tap **Calibration** on the Home Screen > **XY Offset Calibration**.



## Congrats!

You are now ready to print.

## 4.3 Getting Started

### 4.3.1 Install Snapmaker Luban

1. On the Snapmaker official website, click **Software** in the navigation bar. Then, download and install our tailor-made software Snapmaker Luban (hereafter Luban).

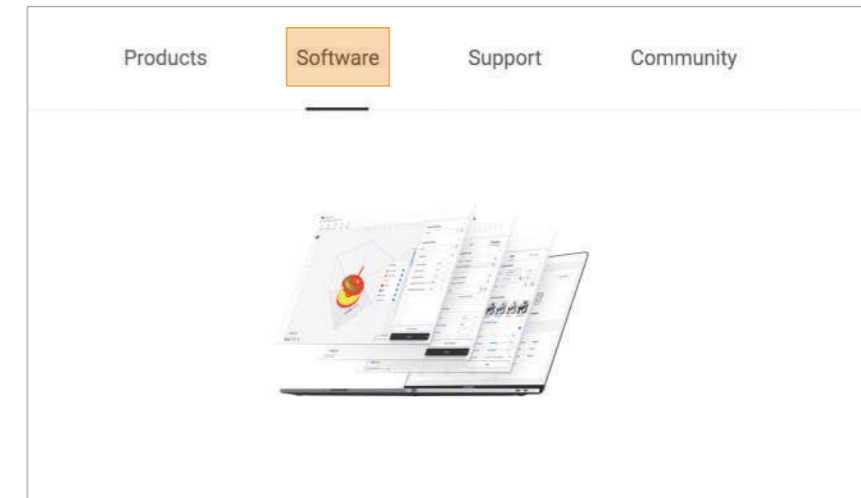

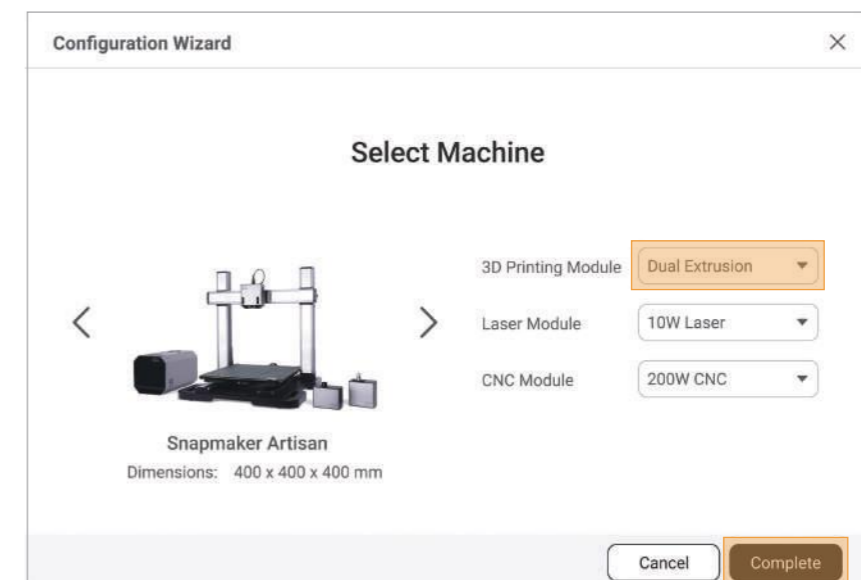

2. Launch Luban, select the language, machine model, and module type, and then click **Complete** to save the settings.



To change these settings later, click **Settings** > **Preferences** in the menu bar.

3. Ensure that your computer and machine are connected to the same Wi-Fi network, and take the following steps to connect Luban with your machine:

- On the Home page of Luban, click  to enter **Workspace**;
- On the **Connection** panel at the top left corner, click **Wi-Fi**;
- Click , select your machine from the drop-down list, and click **Connect**;
- Tap **Yes** on the Touchscreen to allow the connection.

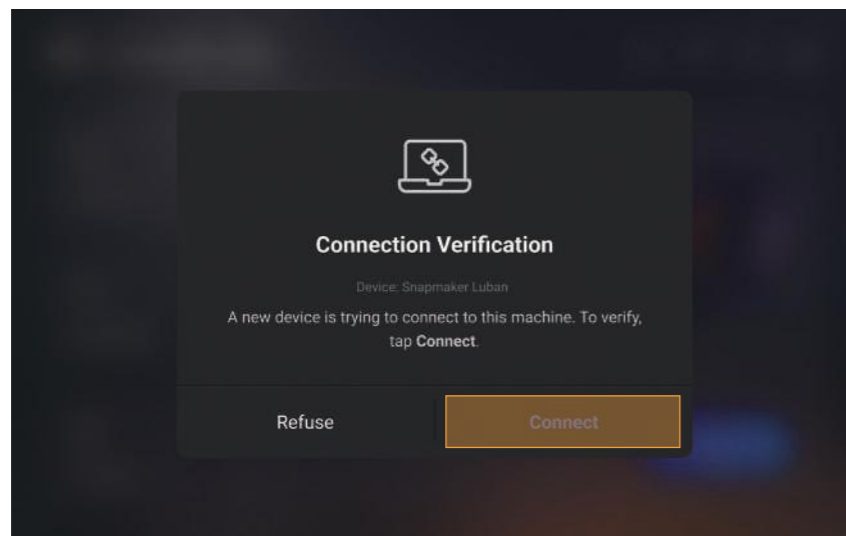
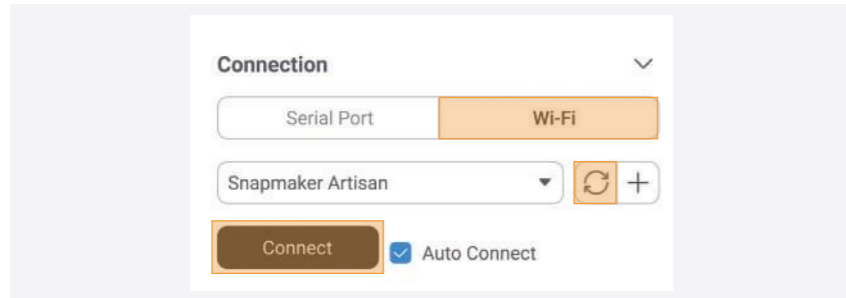

You can also click + and enter the IP address of your machine to manually connect it with Luban. To check the IP address, tap **Settings > About Machine** on the Touchscreen.

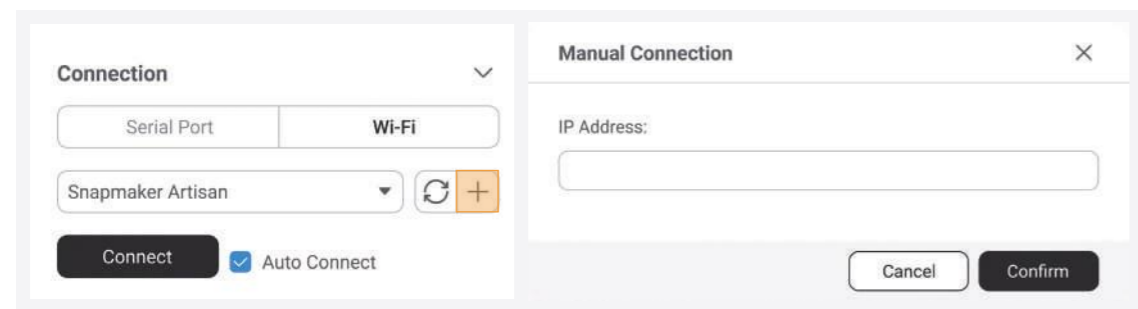



### 4.3.2 Generate the G-code File

1. At the top-left corner of **Workspace**, click **Back** to return to the Home page. Then, click **3D Printing** to enter the **3D Printing G-code Generator**.



2. Follow the Beginner's Guide to get familiar with the basic operations. During this process, Luban will automatically load the test model and generate the G-code file.

 If the Beginner's Guide does not pop up or quits unexpectedly, you can click **Help > Beginner's Guide** in the menu bar.

 You can also click  to import your own files and configure the parameters.

3. After the G-code file is generated, click **Export > Load G-code to Workspace** at the bottom-right corner.

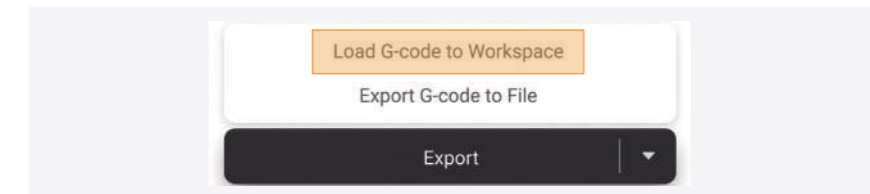



### 4.3.3 Start Your First Print

1. In the **Preview** window, click **Start Job** > **Start on Luban** to create your first print! If the Wi-Fi network is unstable or disconnected during the printing, the ongoing printing process will not be affected.

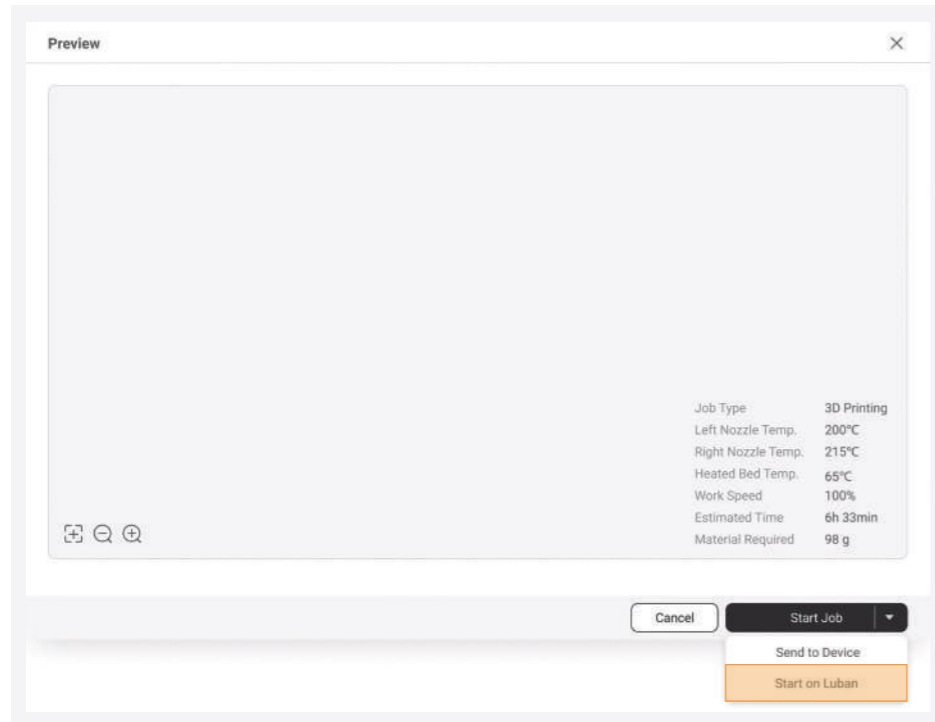

In case of an emergency, press the emergency stop button on top of the Integrated Controller to stop the printing immediately. After you have handled the emergency, you can release the emergency stop button by rotating it clockwise.



Keep the front cover of the Dual Extrusion Module closed throughout the printing process.



You can also send the G-code file to your machine at **Workspace** or via the USB flash drive.

For more detailed information, refer to our online User Manual: On the navigation bar of the Snapmaker official website, click **Support** > **Product Support** > **Snapmaker Artisan** > **User Manual**.

After the printing starts, you need to pay close attention to the first layer adhesion to detect any problems in time to avoid wasting filaments. During the printing, you can tap  to adjust the parameters such as the Z Offset, Work Speed, and Flow Rate, and configure the settings of Enclosure, Air Purifier, and other addons.

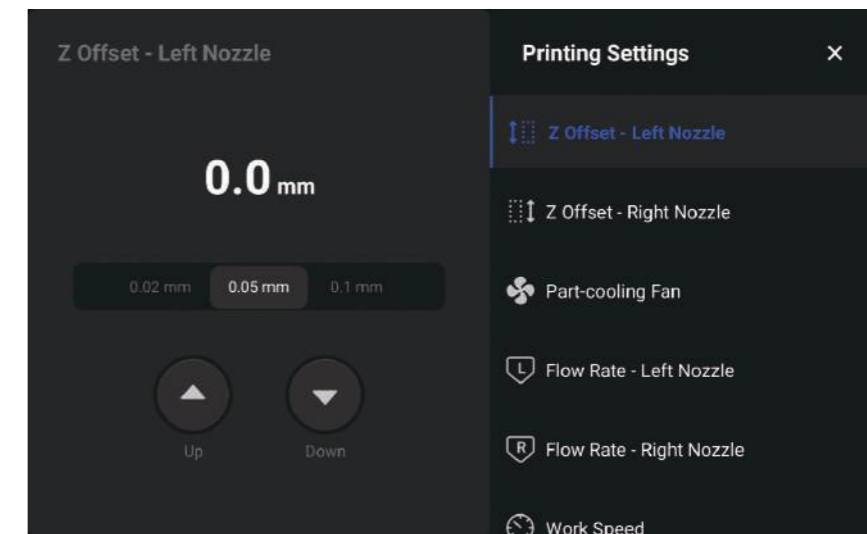
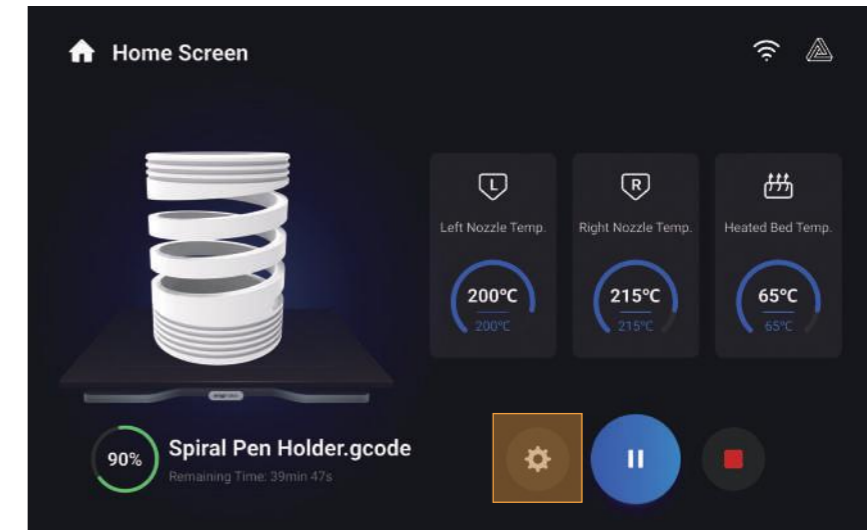

In case of poor adhesion, you can try the following solutions:

**Solution 1:** Adjust the Z Offset during printing to slightly reduce the distance between the nozzle and the build plate. However, please note that the nozzle may fail to extrude successfully or even damage the build plate and itself if too close to the build plate.

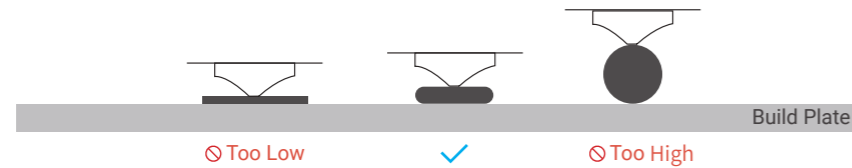

**Solution 2:** Stop the current printing and remove the print from the glass build plate. Then, tap **Calibration** on the Home Screen and redo the Z Offset Calibration and Heated Bed Leveling. The machine will run the calibration processes in Auto Mode by default.

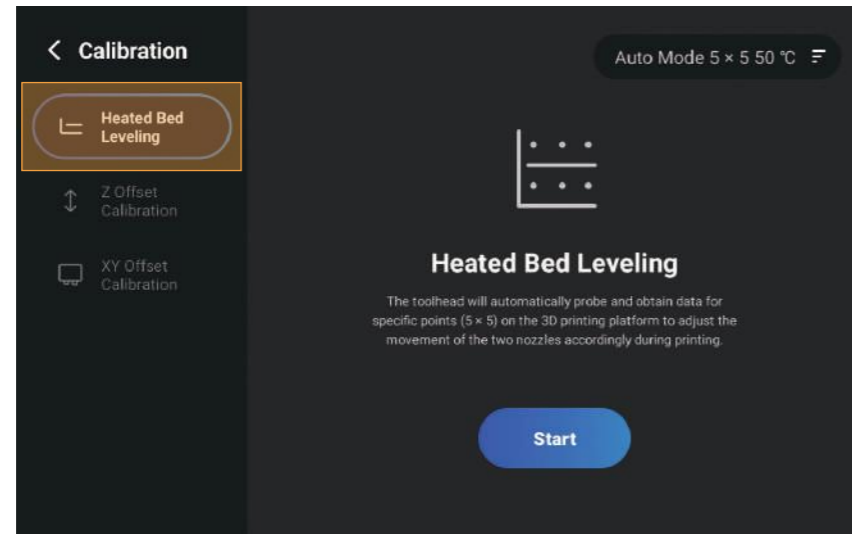

If the calibration results remain unsatisfactory, you can try the following operations:

**Z Offset Calibration:** Tap the top-right corner of the Calibration page to select a different mode, and then redo the calibration.

**Heated Bed Leveling:** Tap the top-right corner of the Calibration page to select **Manual Mode**, increase the calibration points or the bed temperature, and then redo the calibration.

For more detailed introductions to the 3D printing calibrations, refer to our online User Manual: On the navigation bar of the Snapmaker official website, click **Support > Product Support > Snapmaker Artisan > User Manual**.

**Solution 3:** Apply an even layer of water-washable adhesive (like PVP glue sticks) on the printing area to improve the first layer adhesion. After the printing you can wet the cloth with water to wipe off the residual adhesive on the glass build plate.



To configure the settings of Enclosure, refer to [section 3.2: Enclosure Settings](#).

### 4.3.4 Remove the Print

Wait for the nozzles and the heated bed to cool down, and use the palette knife to remove the print from the glass build plate.



Do NOT touch the nozzles and the heated bed with bare hands, as they are still extremely hot right after the printing.



Be careful with the palette knife!



Do NOT scrape or poke the PEI coating of the glass build plate with sharp objects.



You can also take out the glass build plate first, and remove your print from it.



**Share!**

Share your print in our Facebook group and our forum.

# Laser Engraving and Cutting

## 5.1 Laser Engraver and Cutter Assembly

### 5.2 Preparations

- 5.2.1 Set Up the Machine
- 5.2.2 Calibrate the 10W Laser Module
- 5.2.3 Fasten the Material

### 5.3 Getting Started

- 5.3.1 Install Snapmaker Luban
- 5.3.2 Generate the G-code File
- 5.3.3 Start Your First Job

## 5.1 Laser Engraver and Cutter Assembly



01 /06

Loosen the cam handle of the support platform by turning it to the left, and install the laser engraving and cutting platform onto the support platform.

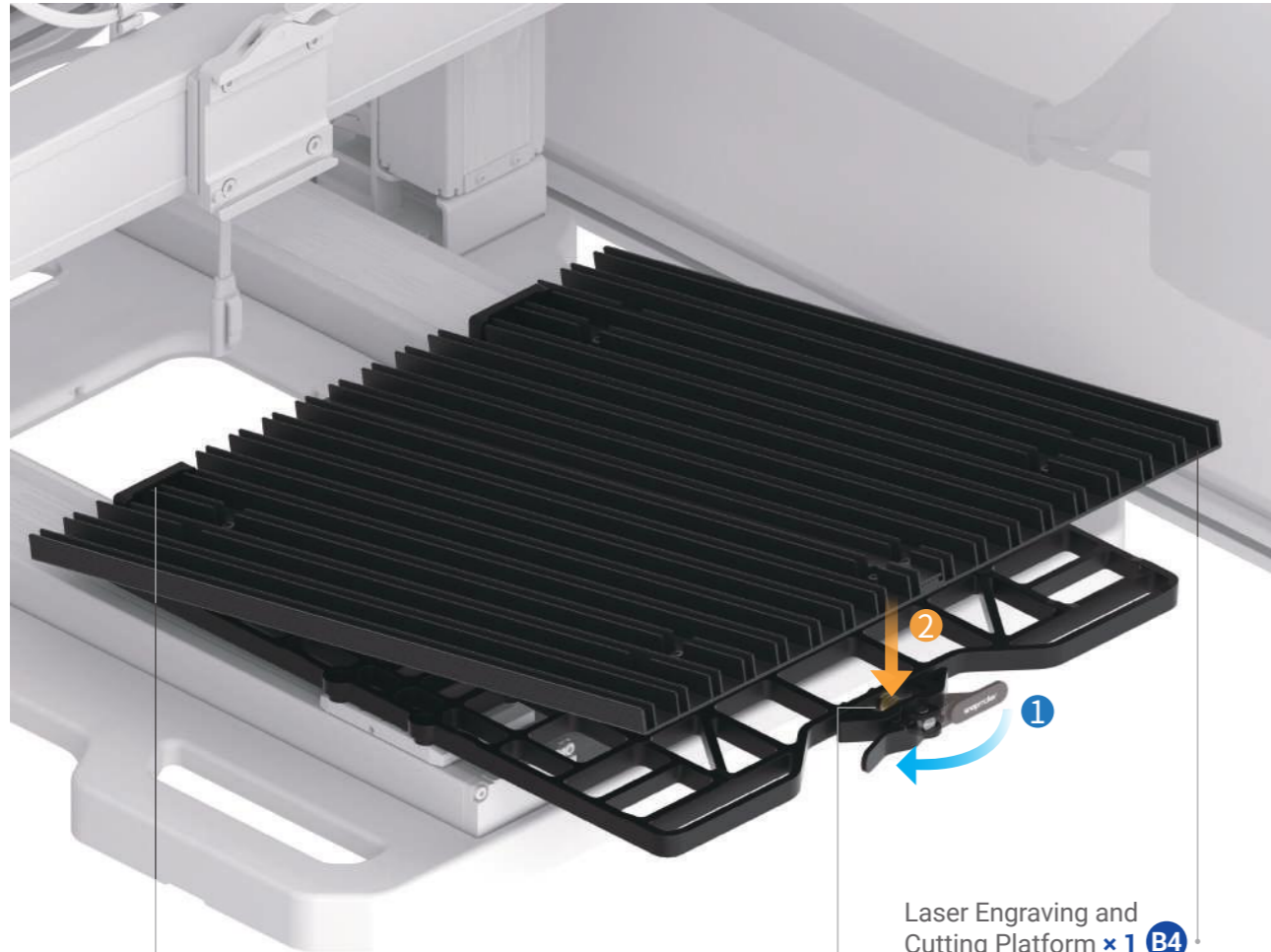

Laser Engraving and Cutting Platform x 1 B4



Ensure that the platform is correctly clamped.

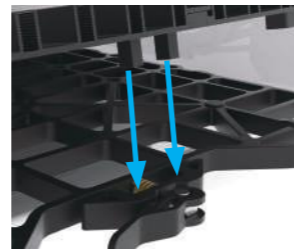

02 /06

Tighten the cam handle of the support platform by turning it to the right.

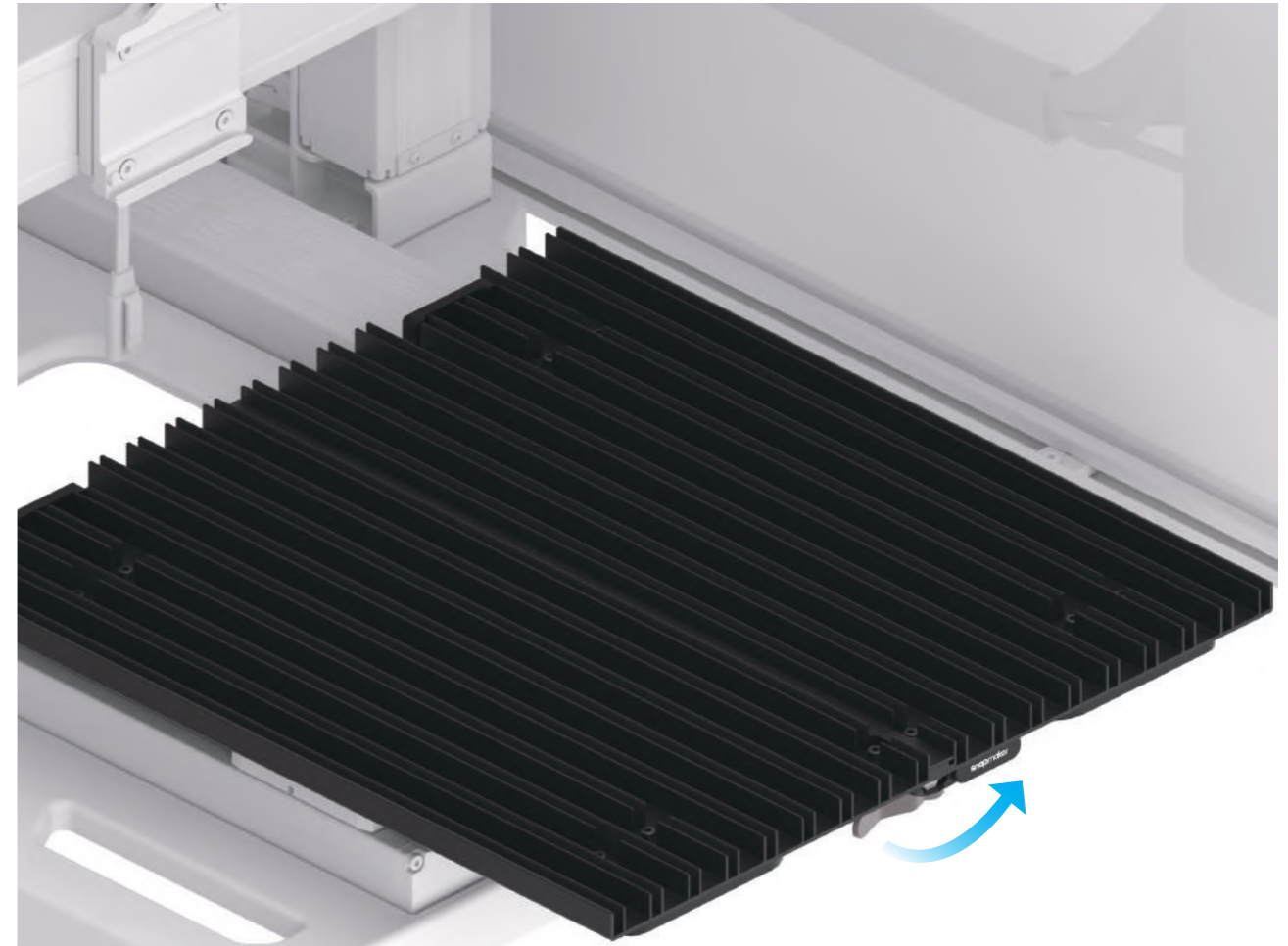

03<sub>/06</sub>

Loosen the cam handle of the toolhead bracket by turning it to the left, and then slide the 10W Laser Module into the bracket.

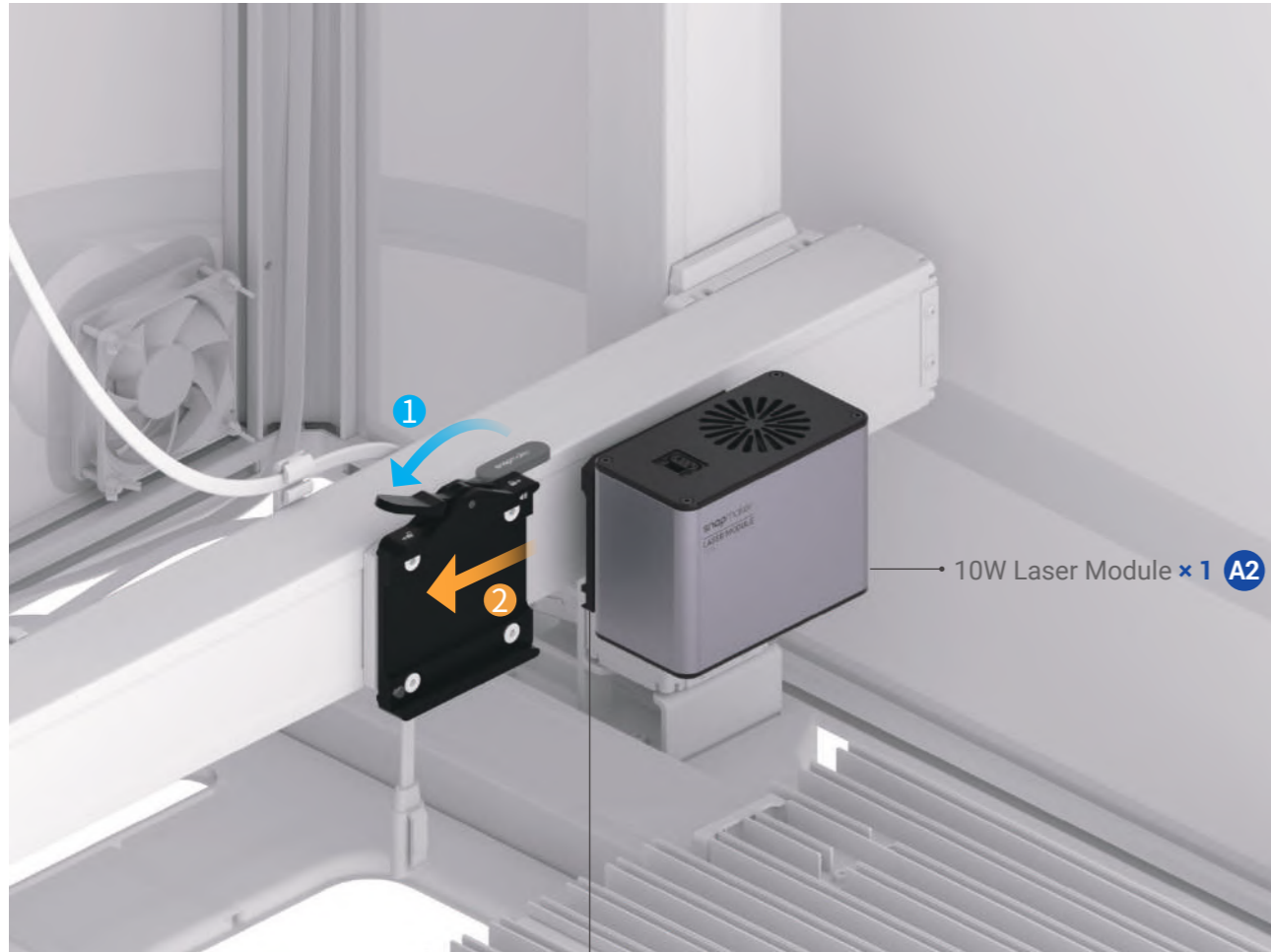

04<sub>/06</sub>

Tighten the cam handle of the toolhead bracket by turning it to the right.

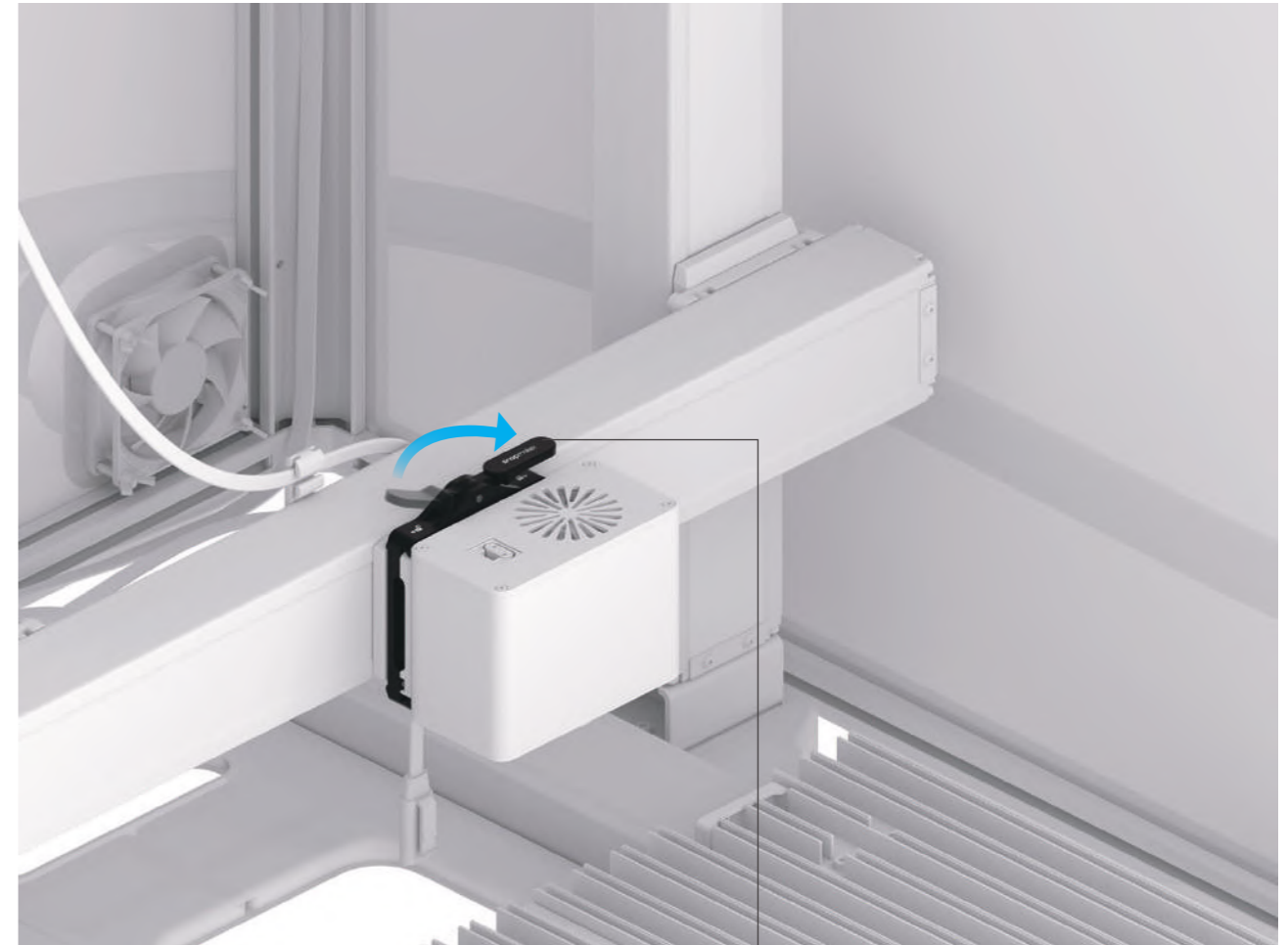

05<sub>/06</sub>

Plug the toolhead cable into the 10W Laser Module.



Ensure that the connector is in the correct direction.

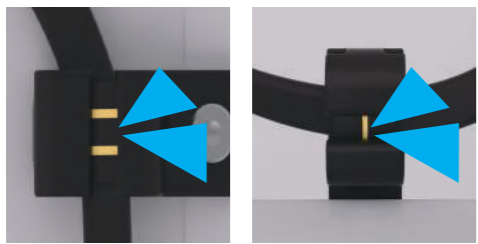
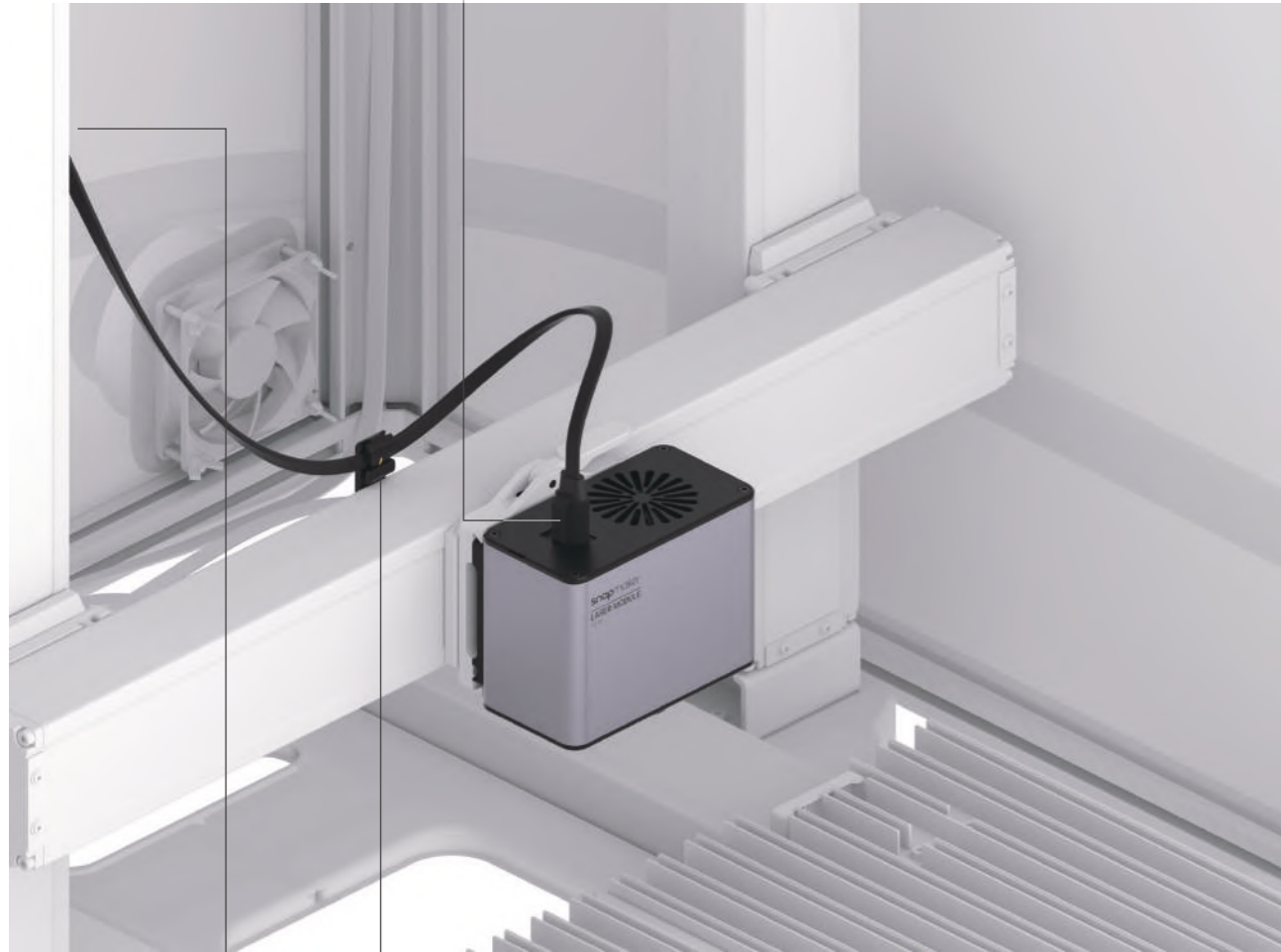

06<sub>/06</sub>

Plug the AC power cable into the Integrated Controller and the electric outlet.



Before plugging, ensure that the power switch is OFF.



Do NOT plug or unplug any cables when the machine is powered on.



AC Power Cable x 1 A6



**Congrats! You have completed the assembly.**

Tear off the base plate sticker and start to make something wonderful with Snapmaker!

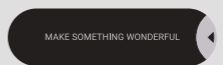

## 5.2 Preparations

### 5.2.1 Set Up the Machine

1. Turn on the power switch on the back of the Integrated Controller.



To restart your machine, wait for at least 5 seconds after power-off.

2. Follow the on-screen instructions to set up the machine: Read the **Terms and Conditions** > Choose the language > Name the machine > Connect to a Wi-Fi network.

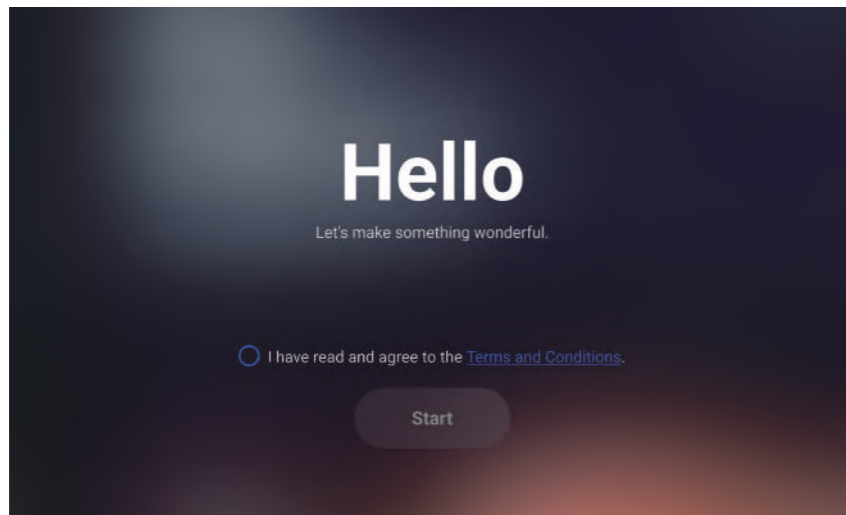

This initial setup wizard appears only the first time you turn on the machine. To change these settings later, tap **Settings** on the Home Screen and select **Wi-Fi**, **Language**, or **About Machine**.

### 5.2.2 Calibrate the 10W Laser Module

For the first-time use of the laser function, the Touchscreen will walk you through the necessary calibrations so that the 10W Laser Module can work properly.

The laser calibration wizard consists of two processes: Thickness Measurement Calibration and Camera Calibration. Before you start the calibration, we recommend that you read this section to learn about each process.

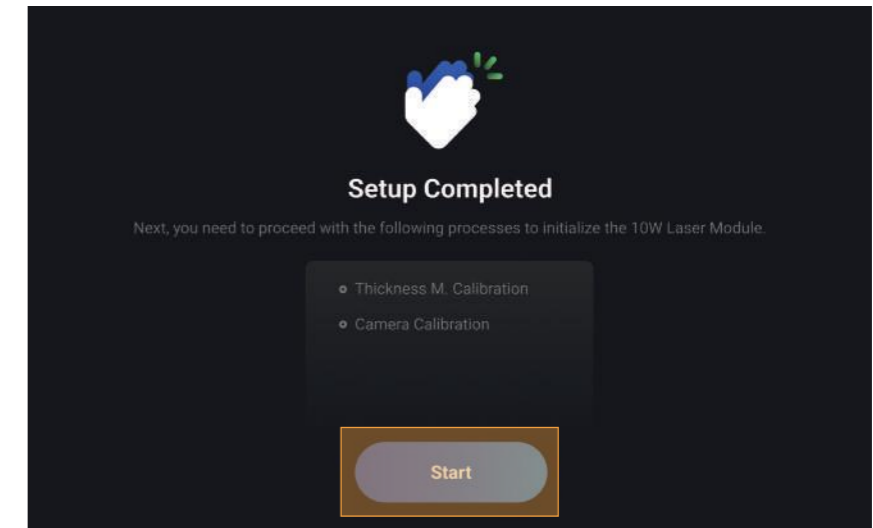

This calibration wizard appears only the first time you use the 10W Laser Module. To redo the calibrations later, tap **Calibration** on the Home Screen and select the corresponding process.

#### 1. Thickness Measurement Calibration

##### Brief Introduction

The 10W Laser Module features a thickness measurement system that uses the triangulation technique. The system includes a red laser emitter that projects a red dot on the material surface and a camera that captures the red dot image to calculate the material thickness.

##### How It Works

The Thickness Measurement Calibration adjusts the parameters in the thickness measurement system to ensure accuracy. In this process, a laser calibration plate with known thickness is first used to help the machine determine the height of the laser engraving and cutting platform and then as a measured object to calibrate the system parameters.

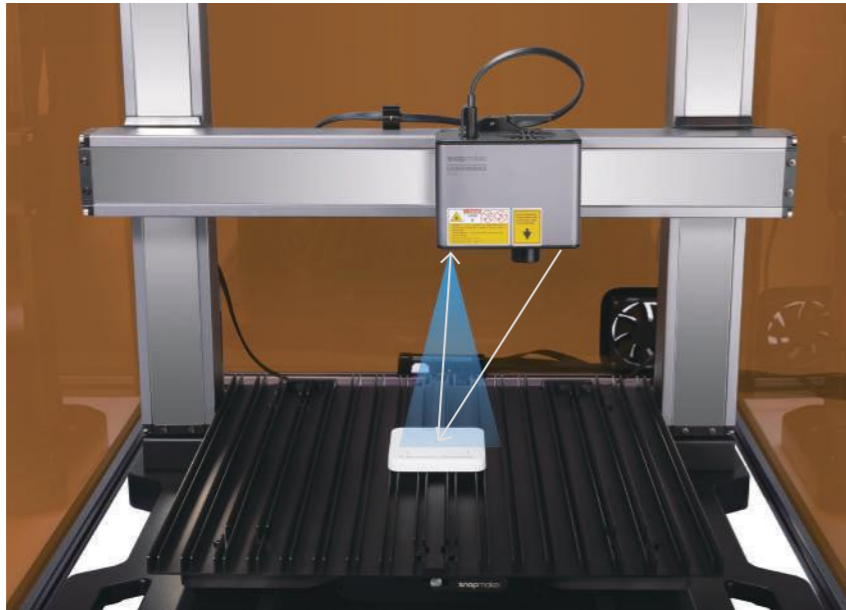

Before you tap **Start**, ensure that the Enclosure door has been closed and then enter the Laser Password on the Touchscreen.

The initial password is the verification code of the machine, which you can find at the bottom of the Integrated Controller.



If you have initialized the 3D printing or the CNC function, you can also check the verification code on the Touchscreen:

- Turn off the machine, and replace the 10W Laser Module with the 3D Printing Module or CNC Module.
- Restart the machine, and tap **Settings > About Machine** on the Touchscreen to check the verification code.



The red laser emitter is a Class 2 laser product. Do NOT look directly into its aperture when the laser beam is being emitted.



Every time after you have reassembled the module or machine, you need to redo the Thickness Measurement Calibration.

## 2. Camera Calibration

### Brief Introduction

The 10W Laser Module contains a wide-angle HD camera to capture the image of the work area, generating a background to edit the laser engraving and cutting objects.

### How It Works

Camera Calibration adjusts the scale of the captured image to display a proper view of the work platform after Camera Capture. During this process, the machine will engrave a square on a piece of blank paper and capture its image to calibrate the camera.

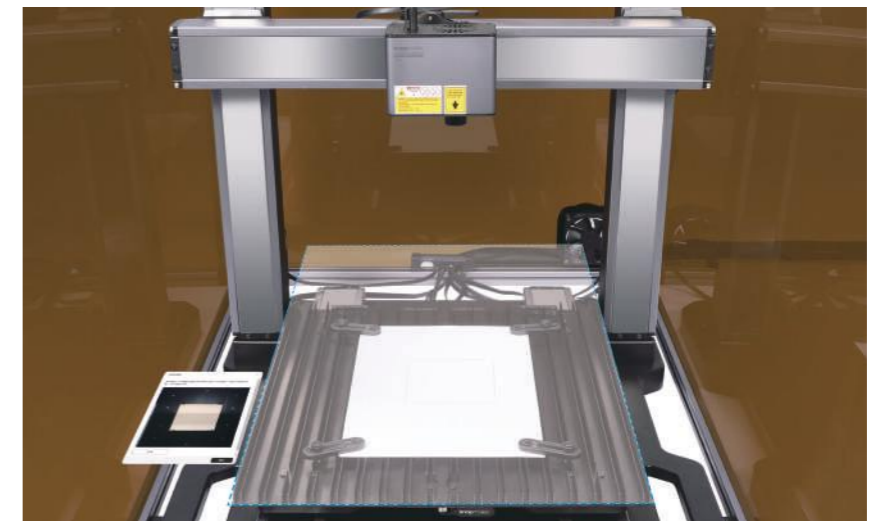

Every time after you have reassembled the module or machine, you need to redo the Camera Calibration.



You can use the provided laser material fixtures to secure the paper.



### 5.2.3 Fasten the Material

Place the provided basswood sheet on the laser engraving and cutting platform, use four fixtures to lock its position as illustrated, and use two screws to secure each fixture.

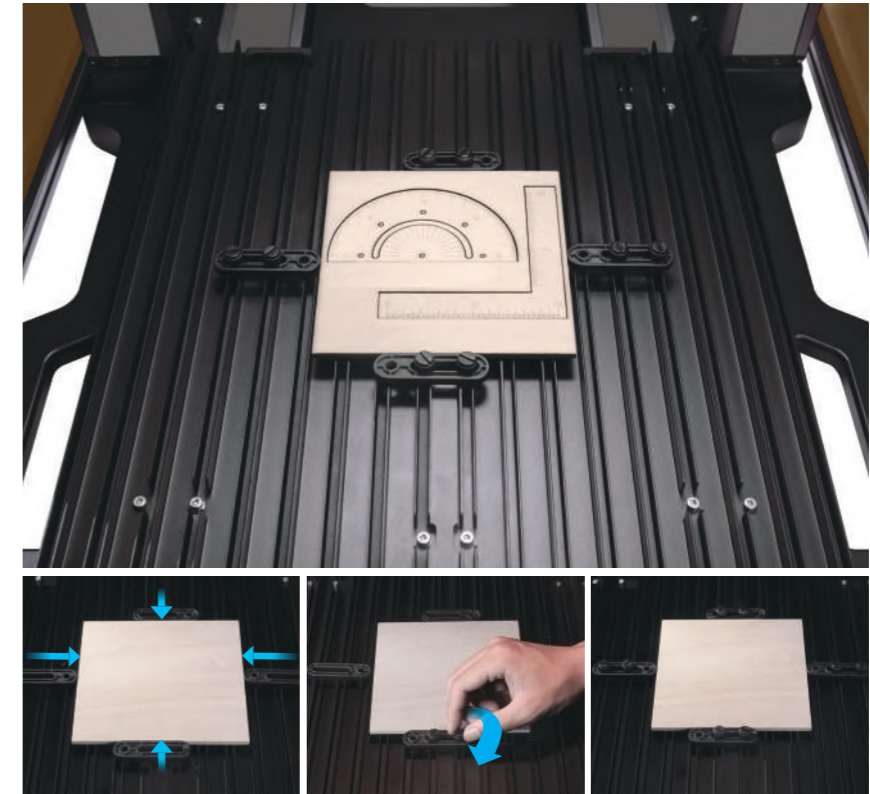

Ensure that the fastening tools will not collide with any parts of the machine.



For ease of operation, you can first detach the laser engraving and cutting platform from the machine, fasten the material on the platform, and install the platform back onto the machine.

You can also put a fixture on each corner of the material and tighten the screws to secure the material. Ensure that the fixtures will not overlap with the engraving and cutting area. This method applies only to materials with less than 8 mm thickness. You can also fasten the materials with other tools like tape.

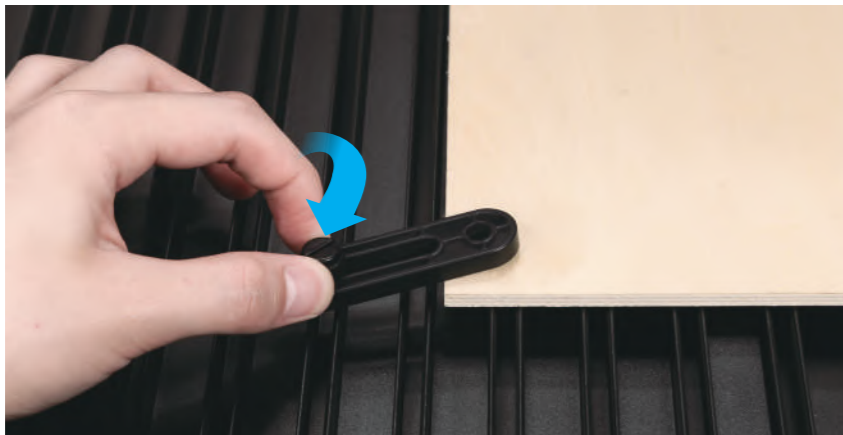

## Congrats!

You are now ready to engrave and cut.

## 5.3 Getting Started

### 5.3.1 Install Snapmaker Luban

1. On the Snapmaker official website, click **Software** in the navigation bar. Then, download and install our tailor-made software Snapmaker Luban (hereafter Luban).

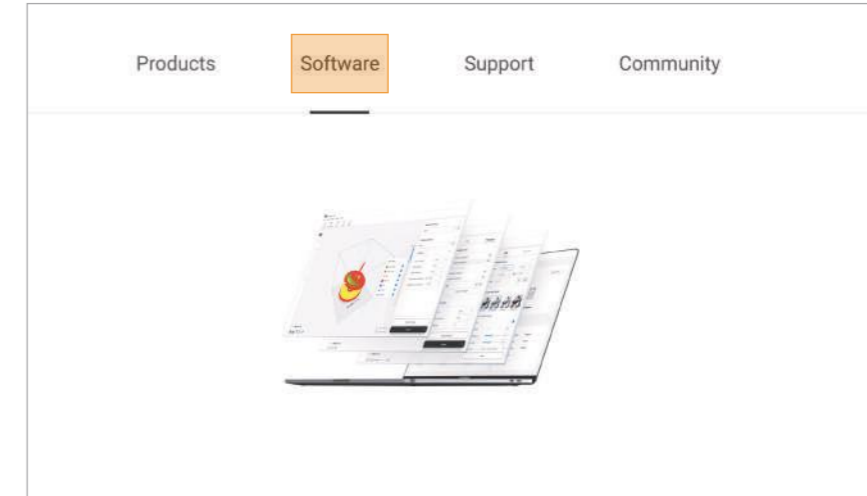

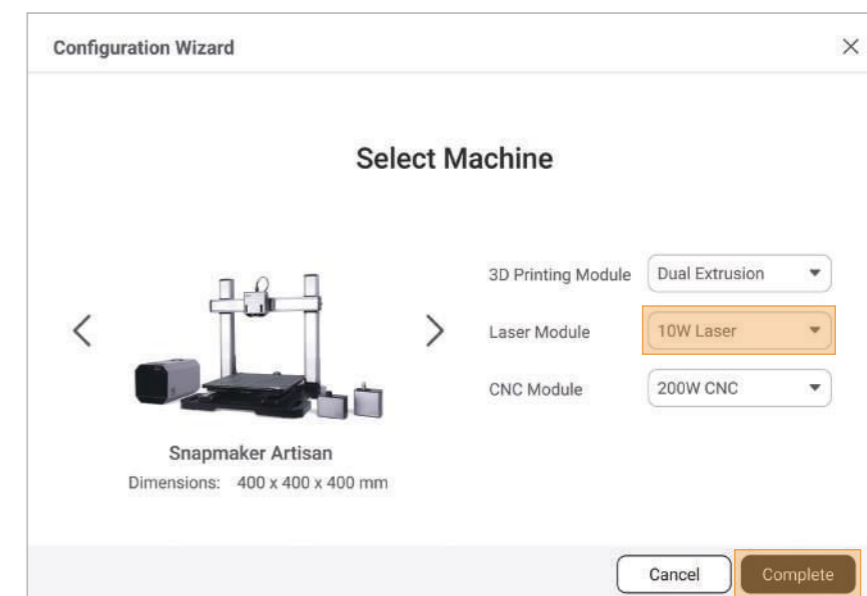

2. Launch Luban, select the language, machine model, and module type, and then click **Complete** to save the settings.



To change these settings later, click **Settings > Preferences** in the menu bar.

3. Ensure that your computer and machine are connected to the same Wi-Fi network, and take the following steps to connect Luban with your machine:

- On the Home page of Luban, click  to enter **Workspace**;
- On the **Connection** panel at the top left corner, click **Wi-Fi**;
- Click , select your machine from the drop-down list, and click **Connect**;
- Tap **Yes** on the Touchscreen to allow the connection.

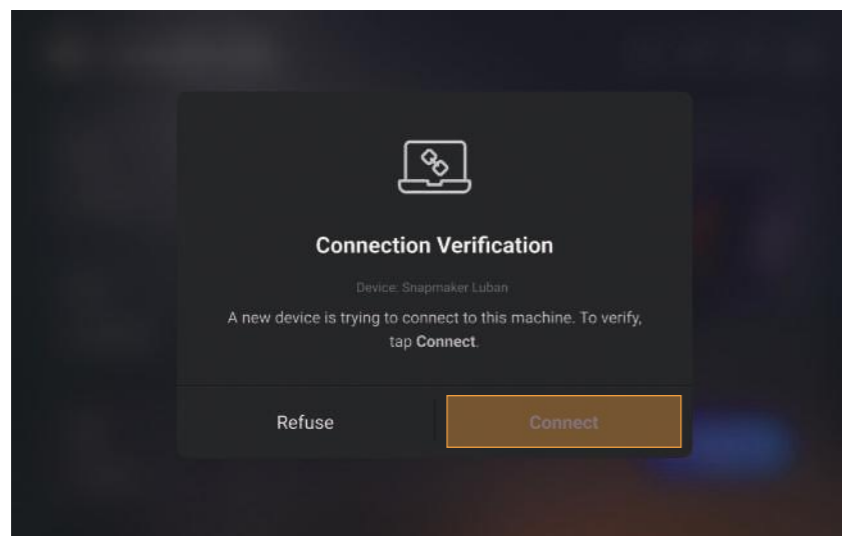
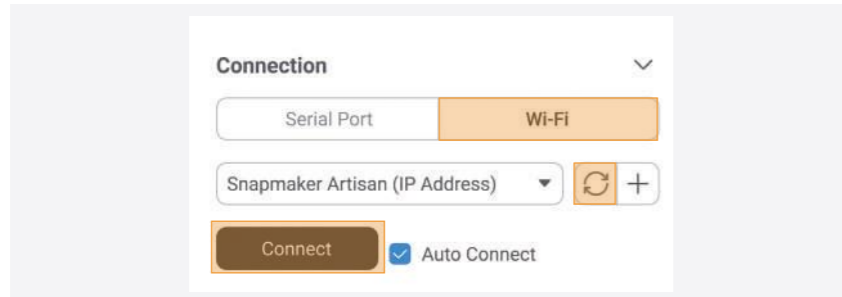

You can also click + and enter the IP address of your machine to manually connect it with Luban. To check the IP address, tap **Settings > About Machine** on the Touchscreen.

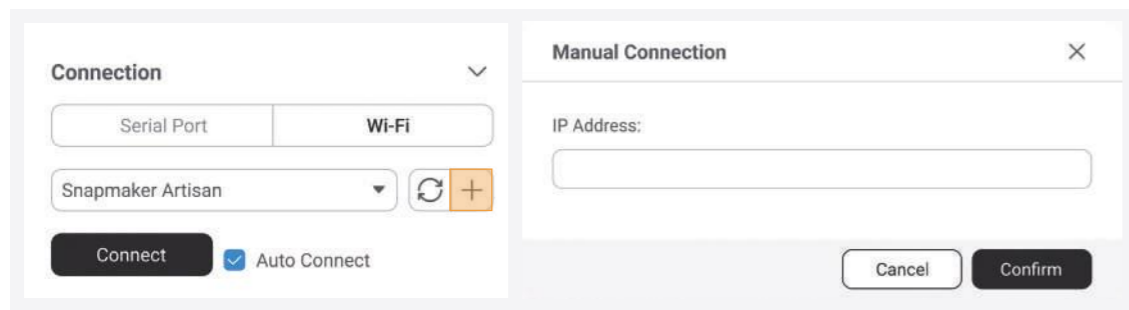

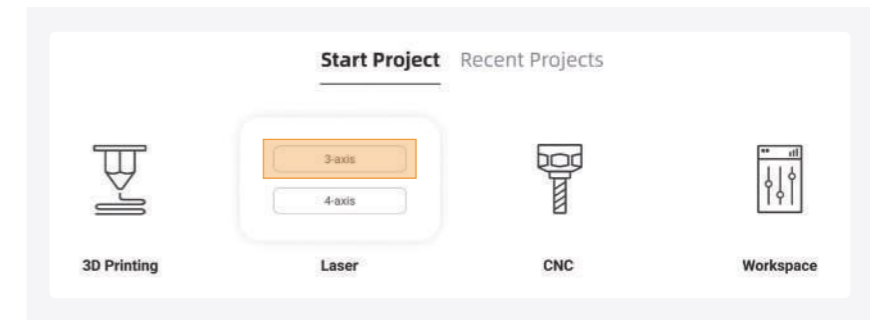

### 5.3.2 Generate the G-code File

1. At the top-left corner of **Workspace**, click **Back** to return to the Home page. Then, click **Laser > 3-axis** to enter the **Laser G-code Generator**.



2. Follow the Beginner's Guide to get familiar with the basic operations. During this process, Luban will automatically load the test model and generate the G-code file.

 If the Beginner's Guide does not pop up or quits unexpectedly, you can click **Help > Beginner's Guide** in the menu bar.

 You can also click  to import your own files and configure the parameters.

3. In the menu bar, click **Camera Capture > Add Background > Normal Mode > Start**. The machine will take a photo of the work area and use it as the background for the object to be engraved or cut. After the photo is captured, click **Confirm**.

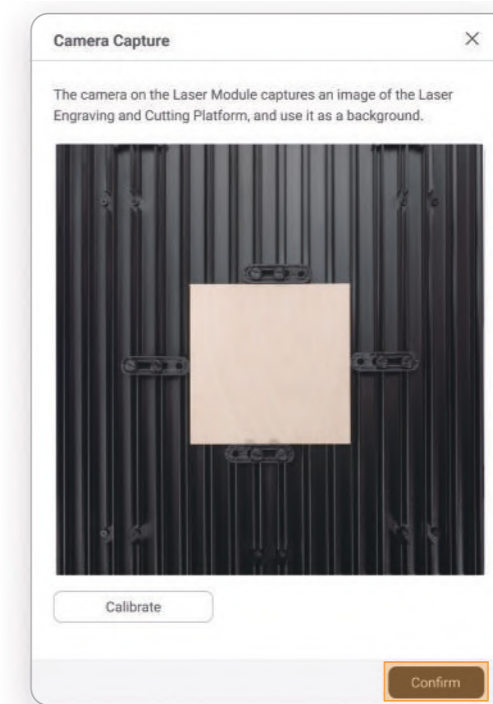
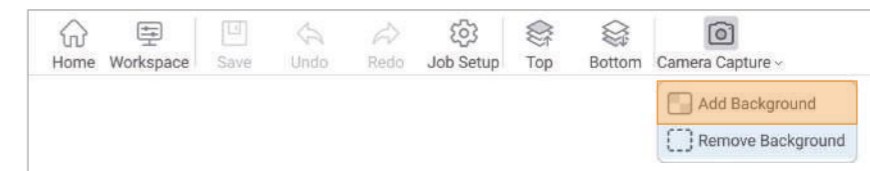



If the captured image is twisted out of shape, click **Calibrate** and follow Luban's instructions to calibrate the camera manually.

4. With the captured image as the background, press Ctrl + A on the keyboard to select all the objects on the canvas and drag them to the area where you want to laser engrave and cut. Then, click **Generate G-code and Preview**.

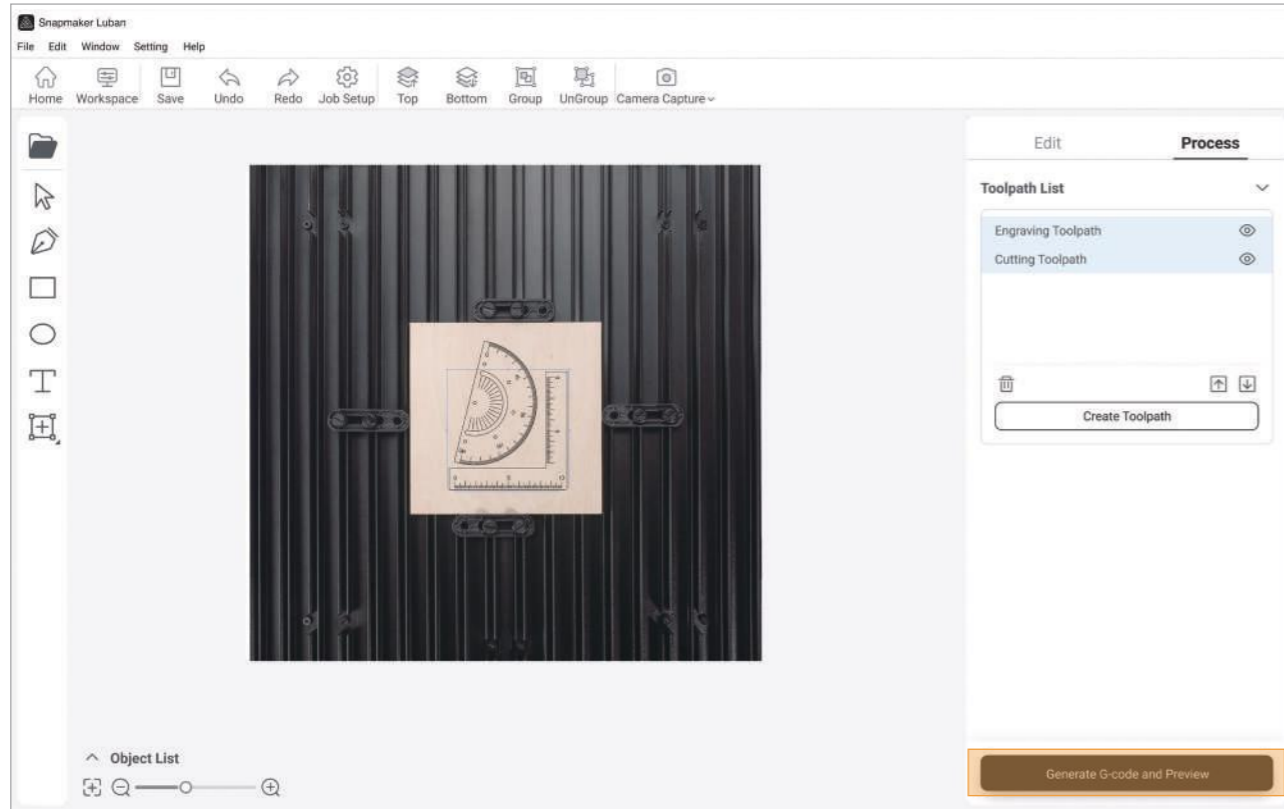

For detailed information about generating G-code files, refer to our online User Manual: On the navigation bar of the Snapmaker official website, click **Support > Product Support > Snapmaker Artisan > User Manual**.

### 5.3.3 Start Your First Job

1. At the bottom-right corner of Luban, click **Export > Load G-code to Workspace**.

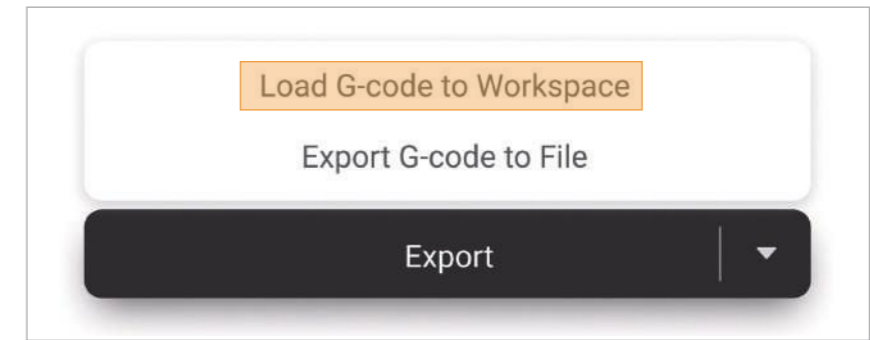

2. In the **Preview** window, click **Start Job > Start on Luban**. In the **Select Mode** window, select **Automatic Thickness Measurement** and click **Start**.

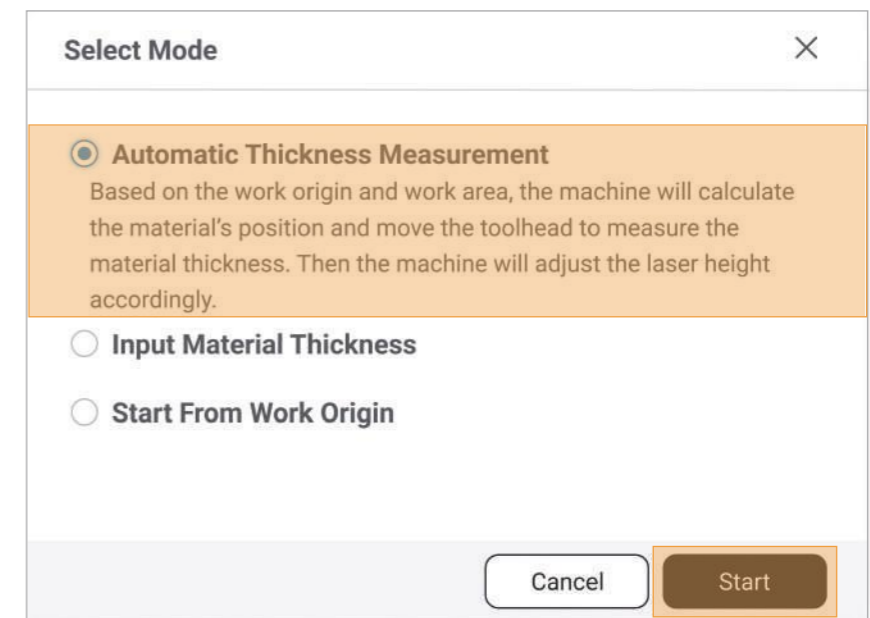

Before you click **Start**, ensure that the Enclosure is correctly assembled and powered on, and that the Enclosure door has been closed.



In case of an emergency, press the emergency stop button on top of the Integrated Controller to stop the printing immediately. After you have handled the emergency, you can release the emergency stop button by rotating it clockwise.



If you use a material with one of the following properties, the thickness measurement may fail.



- The material thickness exceeds 50 mm.
- The material texture is transparent.
- The material surface is glossy or specular.
- The material color is red or black.
- The material is hollow.

Luban provides three laser focusing modes. You are recommended to use **Automatic Thickness Measurement** as instructed by this guide, since this mode is the most convenient one. You can also select other modes based on your needs.



- **Input Material Thickness:** If the material thickness is known, you can use this mode and enter the material thickness.
- **Start From Work Origin:** To use this mode, you must first manually focus the laser and set the Work Origin. For detailed steps, refer to our online User Manual: On the navigation bar of the Snapmaker official website, click Support > Product Support > Snapmaker Artisan > User Manual.

As for the way to determine the laser engraving and cutting position, in addition to the Camera Capture method introduced above, you can also try the Work Origin method.



As for the way to start a laser job, you can also use the USB cable to connect Luban with the machine, or transfer the G-code file to the machine through a USB flash drive or Wi-Fi and start jobs on the Touchscreen.

For more detailed information, refer to our online User Manual: On the navigation bar of the Snapmaker official website, click **Support > Product Support > Snapmaker Artisan > User Manual**.



## Share!

Share your finished work in our Facebook group and our forum.

3. After the laser engraving and cutting job is completed, open the Enclosure and take out the finished work.

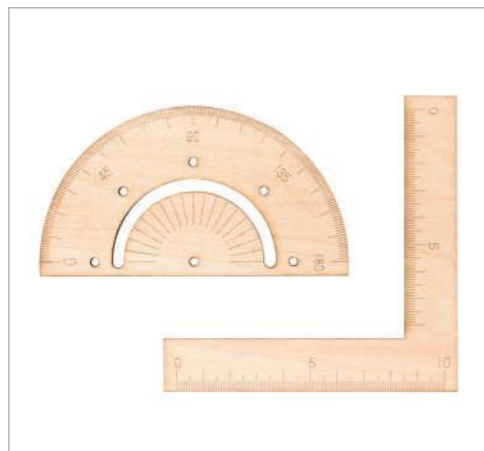

# CNC Carving and Cutting

## 6.1 CNC Carver and Cutter Assembly

## 6.2 Preparations

- 6.2.1 Set Up the Machine
- 6.2.2 Fasten the Material
- 6.2.3 Attach the CNC Bit

## 6.3 Getting Started

- 6.3.1 Install Snapmaker Luban
- 6.3.2 Generate the G-code File
- 6.3.3 Set the Work Origin and Start Carving
- 6.3.4 Clean the Finished Work and the Machine

## 6.1 CNC Carver and Cutter Assembly



01 /06

Loosen the cam handle of the support platform by turning it to the left, and install the CNC carving and cutting platform onto the support platform.

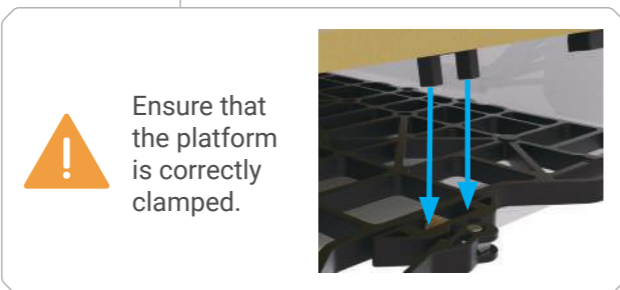
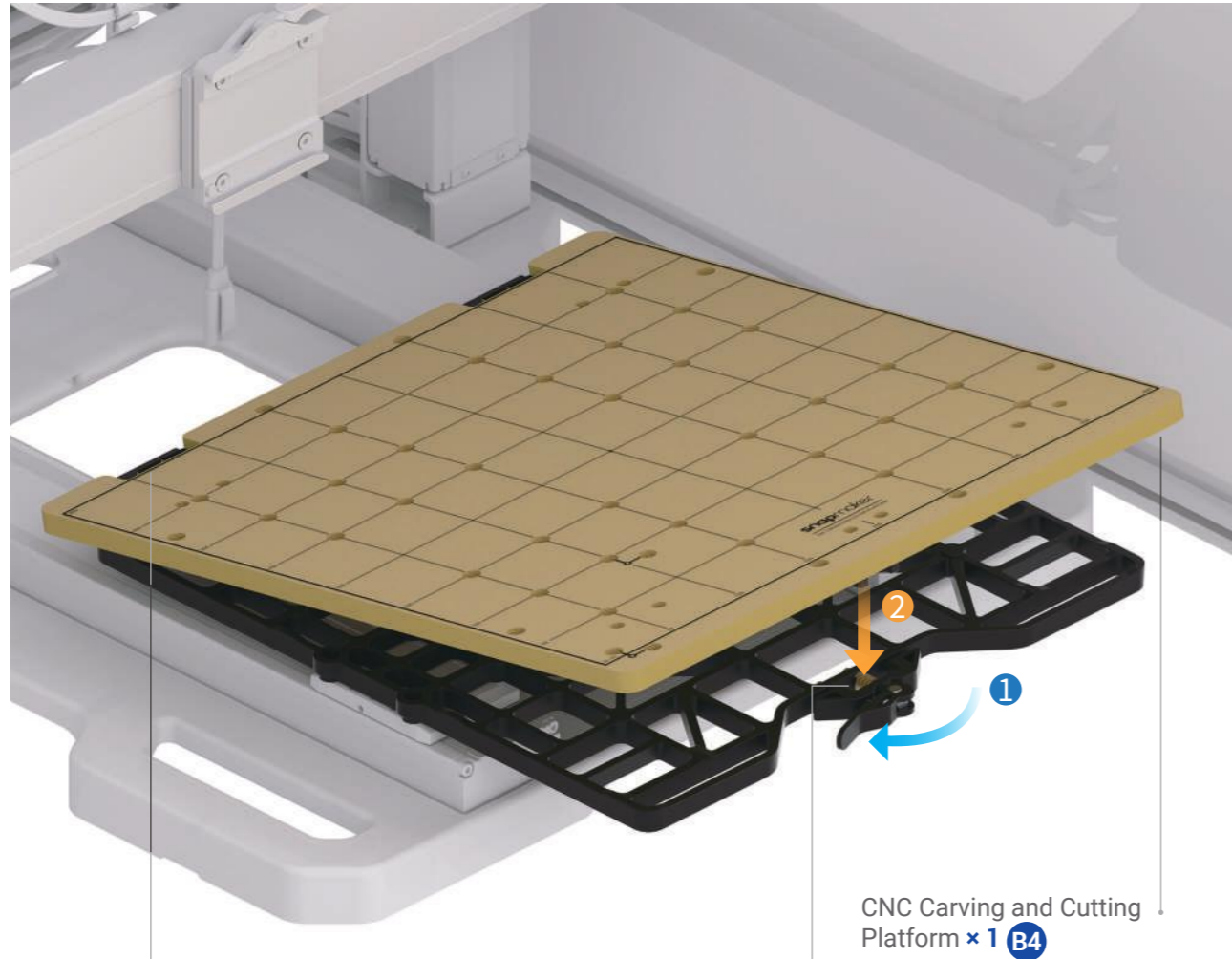

Ensure that the whole CNC carving and cutting platform is installed horizontally without being tilted in any direction.

02 /06

Tighten the cam handle of the support platform by turning it to the right.

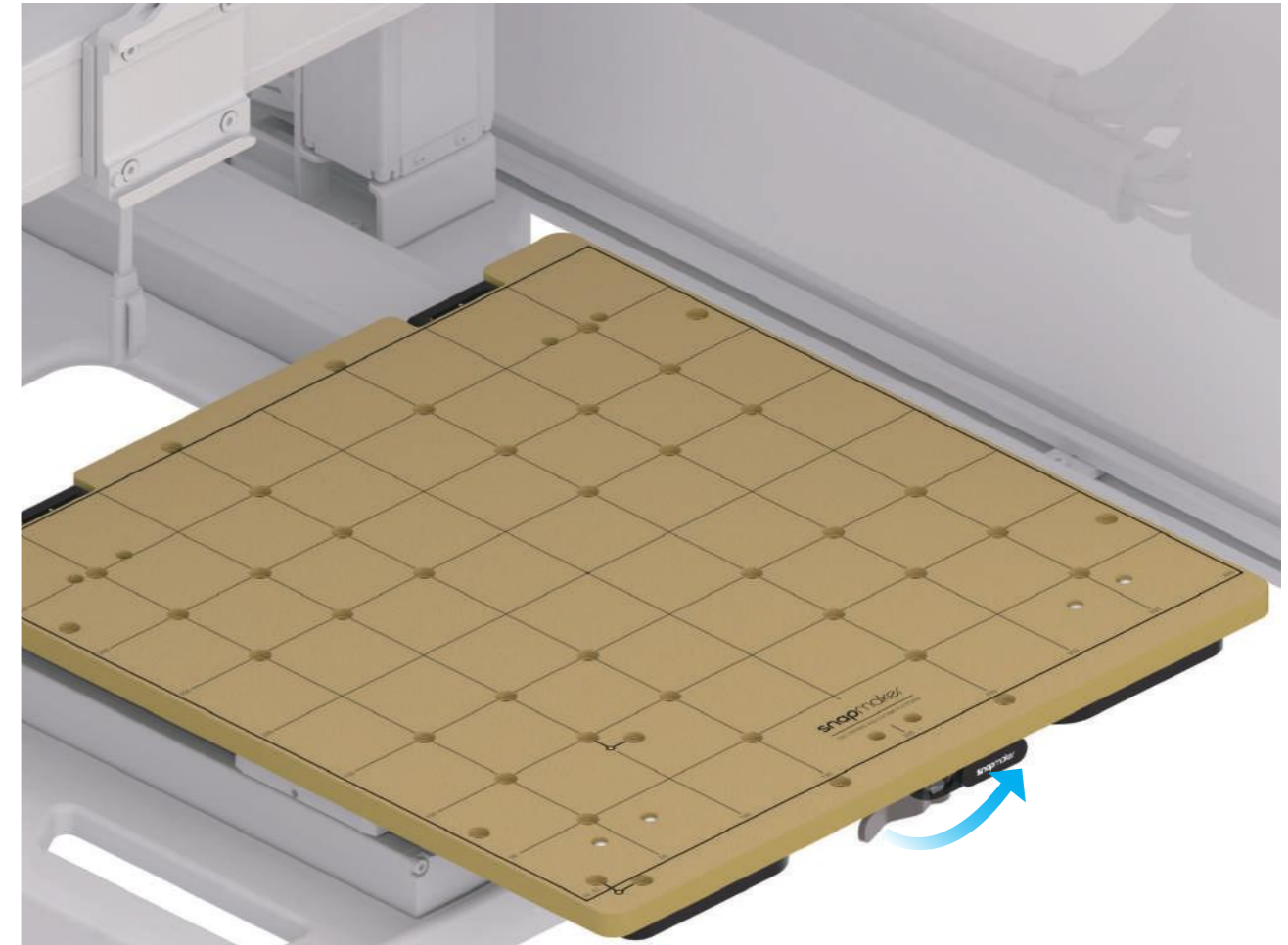

03<sub>/06</sub>

Loosen the cam handle of the toolhead bracket by turning it to the left, and slide the 200W CNC Module into the bracket.

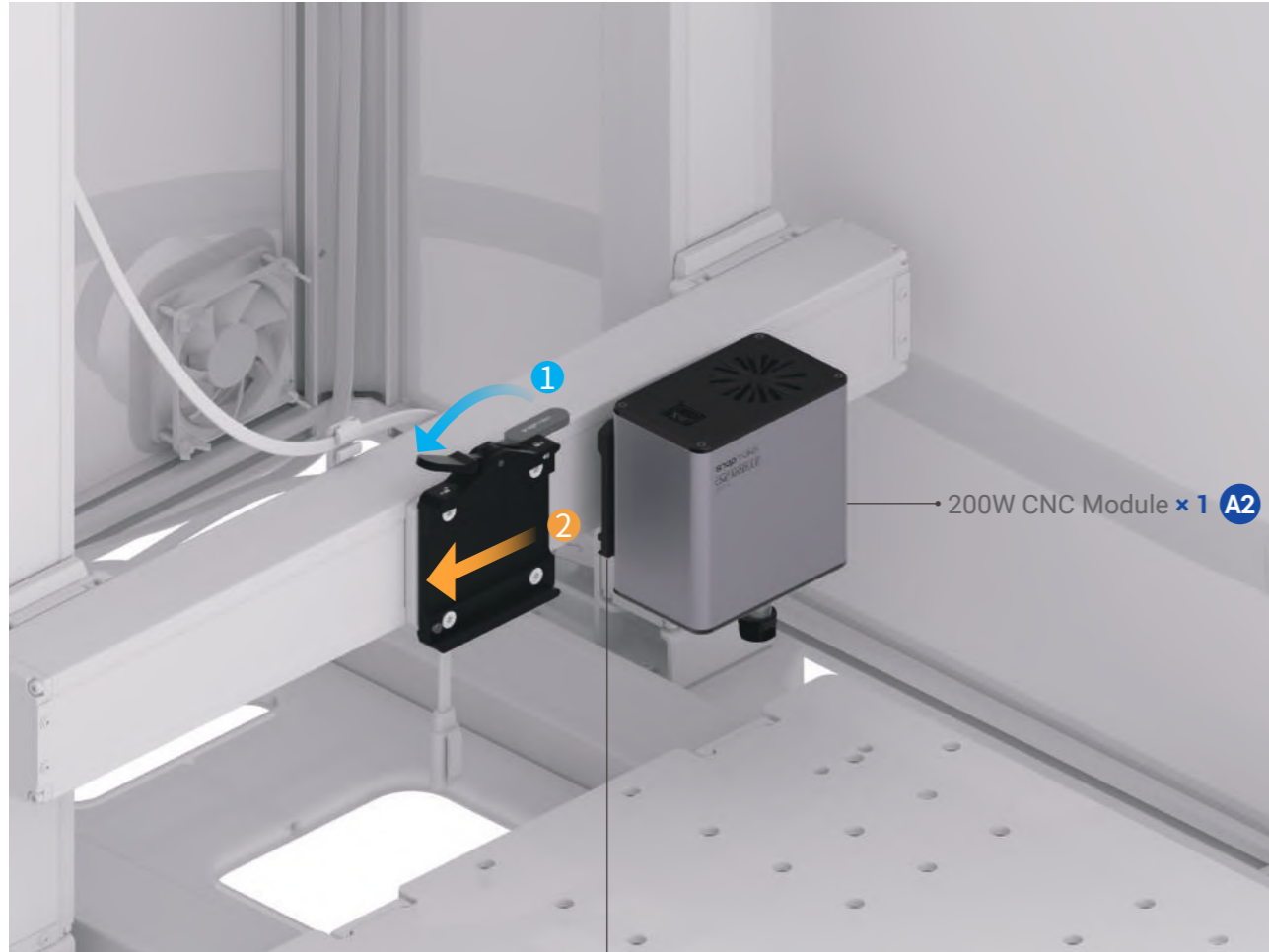

 Make sure to fully slide the toolhead into the bracket.



04<sub>/06</sub>

Tighten the cam handle of the toolhead bracket by turning it to the right.

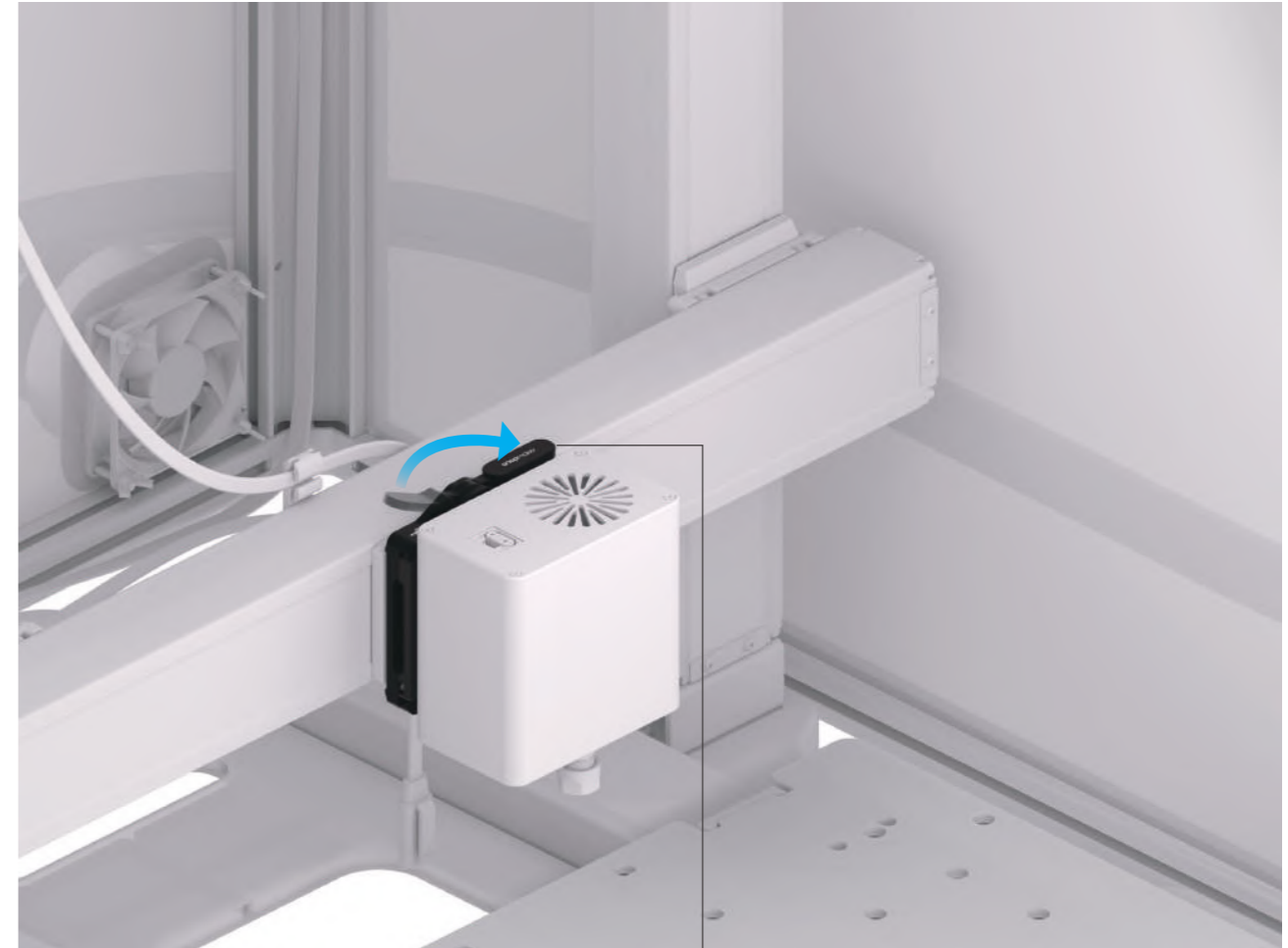

 Make sure to fully tighten the cam handle.





05<sub>/06</sub>

Plug the toolhead cable into the 200W CNC Module.



Ensure that the connector is in the correct direction.

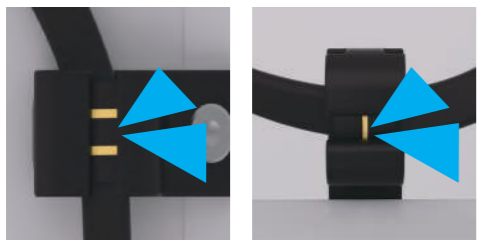
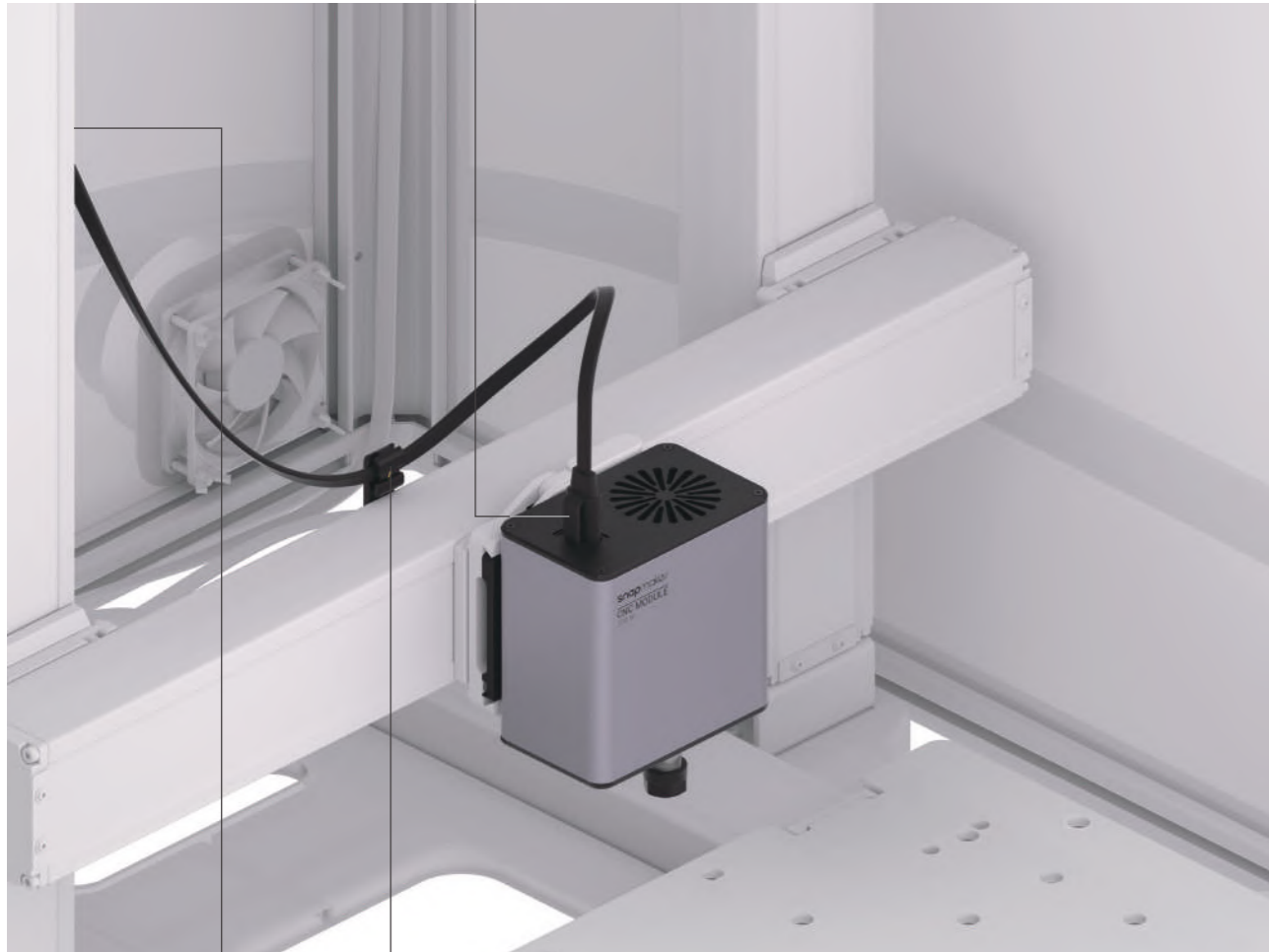

06<sub>/06</sub>

Plug the AC power cable into the Integrated Controller and the electric outlet.



Before plugging, ensure that the power switch is OFF.



Do NOT plug or unplug any cables when the machine is powered on.



AC Power Cable × 1 A6



**Congrats! You have completed the assembly.**

Tear off the base plate sticker and start to make something wonderful with Snapmaker!

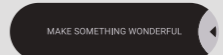

## 6.2 Preparations

### 6.2.1 Set Up the Machine

1. Turn on the power switch on the back of the Integrated Controller.



To restart your machine, wait for at least 5 seconds after power-off.

2. Follow the on-screen instructions to set up the machine: Read the **Terms and Conditions** > Choose the language > Name the machine > Connect to a Wi-Fi network.

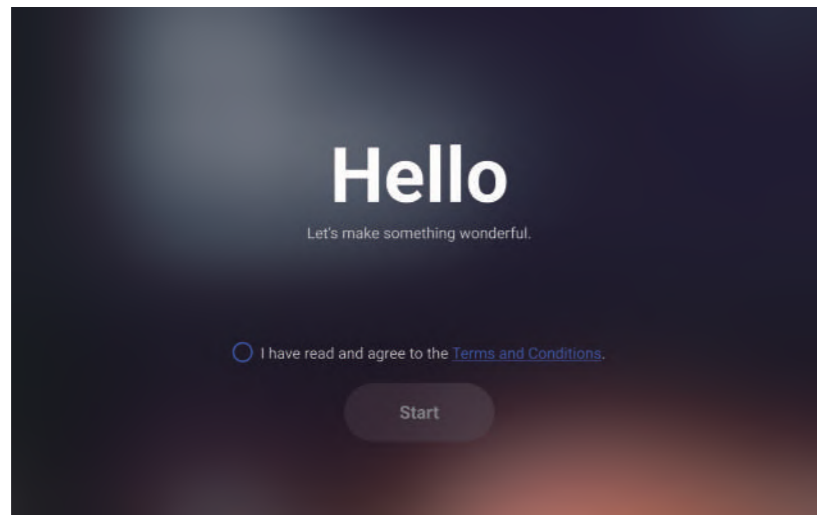

This initial setup wizard appears only the first time you turn on the machine. To change these settings later, tap **Settings** on the Home Screen and select **Wi-Fi**, **Language**, or **About Machine**.

3. Follow the on-screen instructions to get familiar with the basic operations before starting a CNC job.

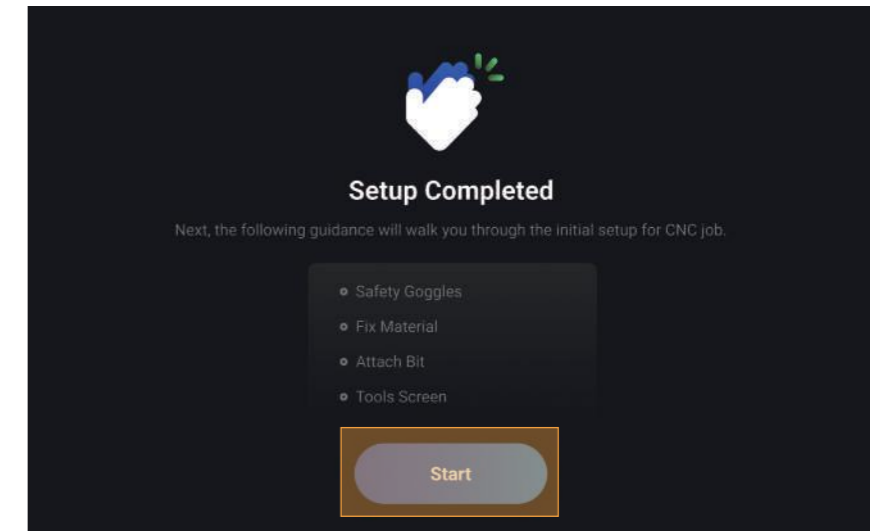

## 6.2.2 Fasten the Material

1. Detach the CNC carving and cutting platform and place the provided HDF sheet on the platform center. Then, assemble the clamp set as illustrated and fasten the material by tightening the star knobs.

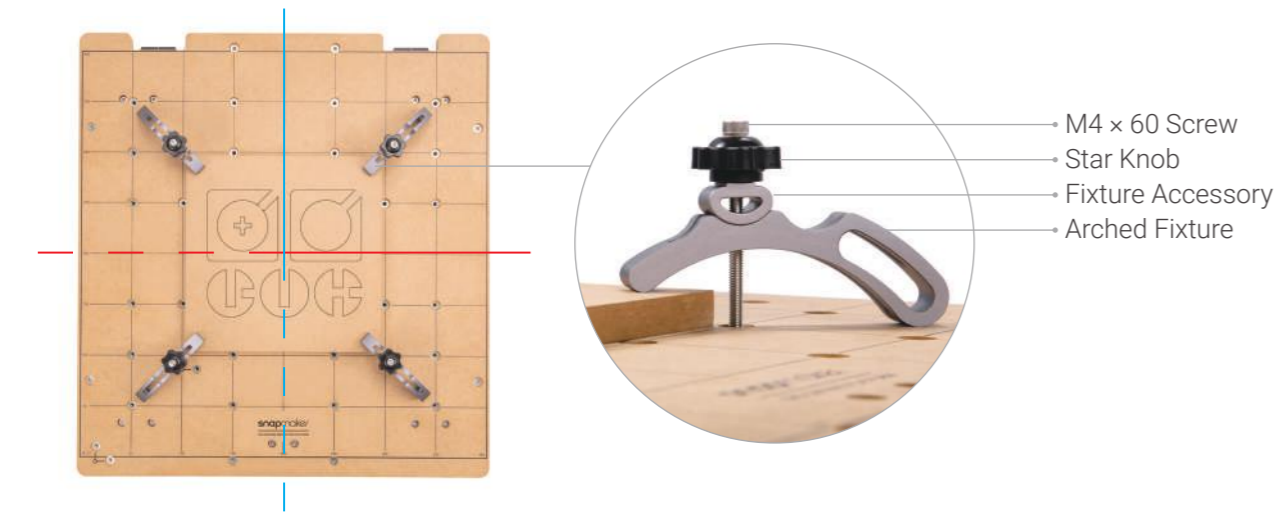

 The size of our test model is 152.2 mm x 123.9 mm. Ensure that the clamp set will not impede the movement of the CNC bit.

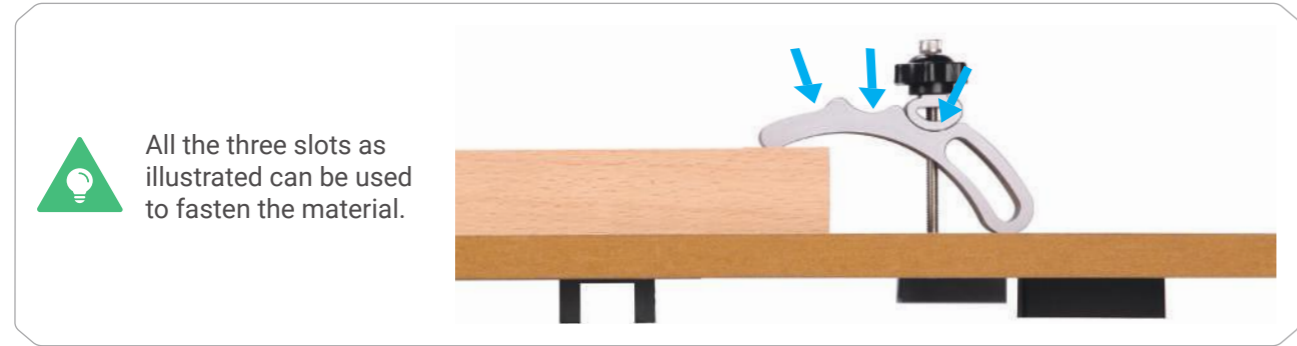

2. Check the positions of the screws to ensure that they are not over-screwed and penetrating the CNC carving and cutting platform.



3. Attach the CNC carving and cutting platform again to the support platform by referring to [section 6.1](#) of this guide.

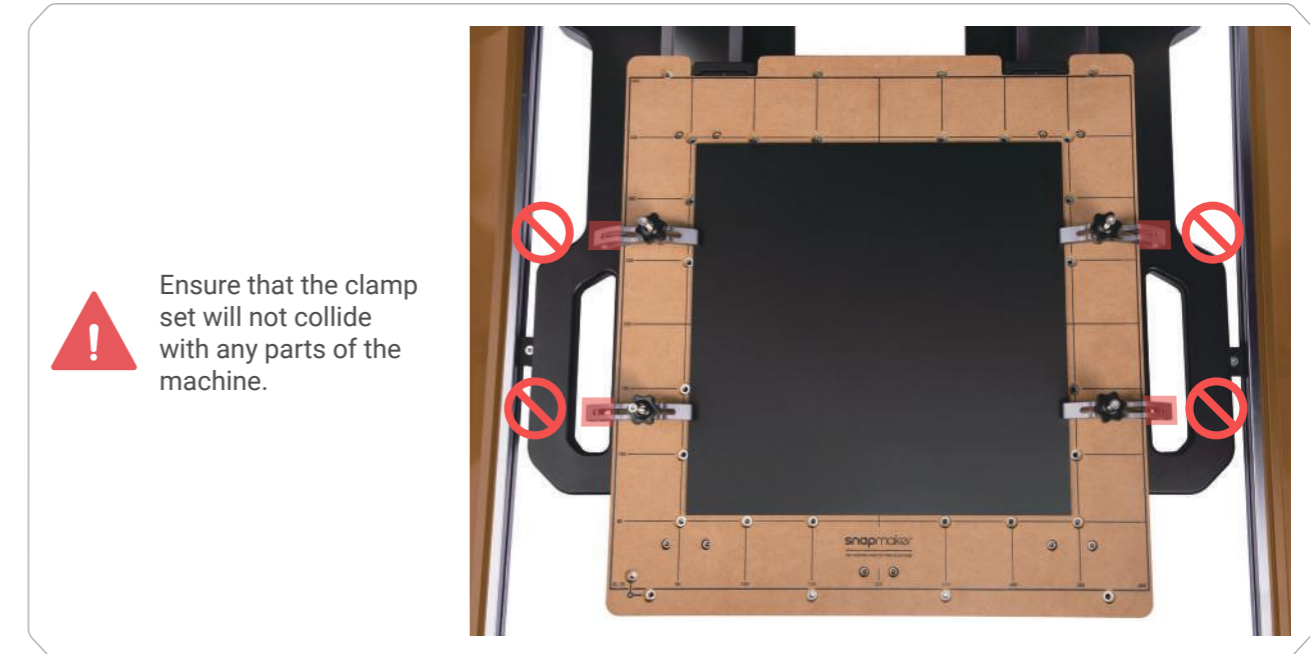

## 6.2.3 Attach the CNC Bit

### CNC Bit Introduction

#### Flat End Mill (Single-flute) and Flat End Mill (Double-flute)

The flat end mill is typically used for drilling, slotting, or cutting materials into flat surfaces. With a larger flute valley for better chip evacuation, the flat end mill (single-flute) is ideal for machining plastic materials.

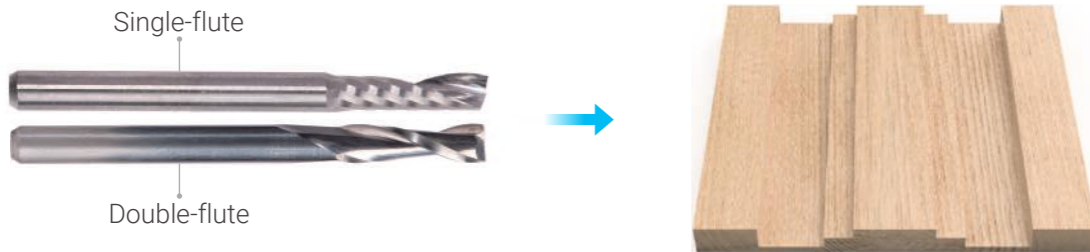

#### Straight Groove V-bit (Double-flute)

The straight groove V-bit (double-flute) is typically used for precision machining, such as relief carving and curved surface milling.

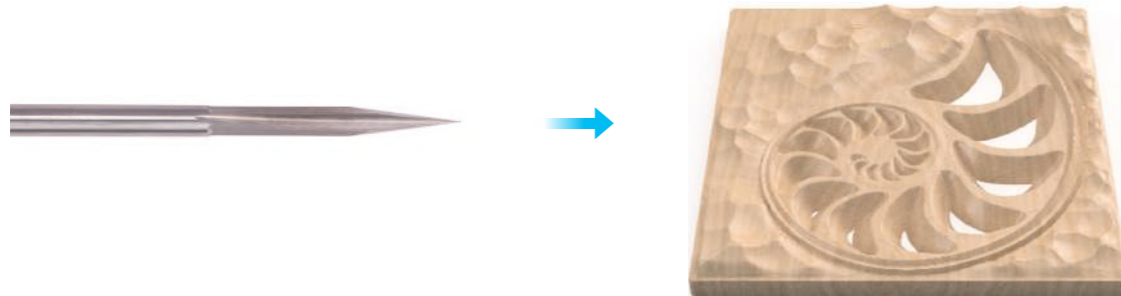

### How to Attach the CNC Bit

1. Obliquely insert the ER11 collet into the ER11 nut until it snaps into place.



2. First, put on the CNC Safety Goggles. Then, insert the CNC bit into the ER11 collet (**the double-flute flat end mill is required for our test model**) and keep pushing the bit until its end bottoms against the shell of the ER11 collet.



Handle the CNC bits with caution and keep them away from children.

3. Twist the entire unit onto the shank as tight as possible, and then completely tighten the ER11 nut with the open-end wrenches.



14 mm Open-end Wrench

17 mm Open-end Wrench



## Congrats!

You are now ready to carve and cut.

## 6.3 Getting Started

### 6.3.1 Install Snapmaker Luban

1. On the Snapmaker official website, click **Software** in the navigation bar. Then, download and install our tailor-made software Snapmaker Luban (hereafter Luban).

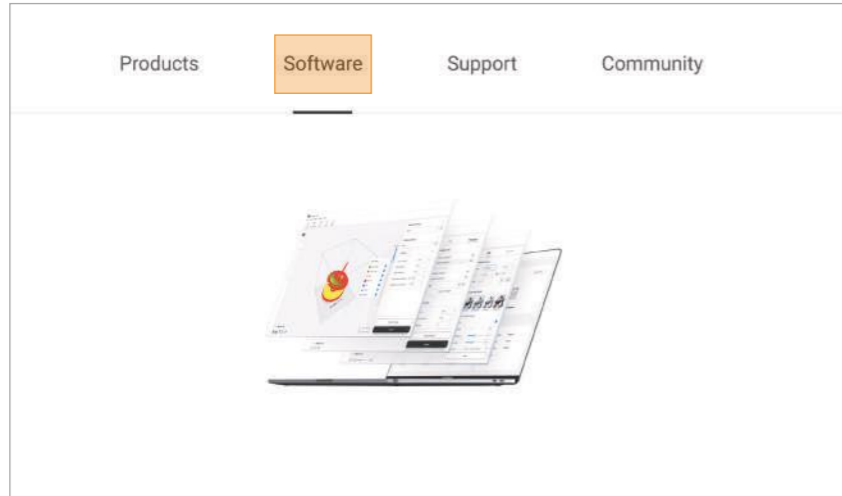

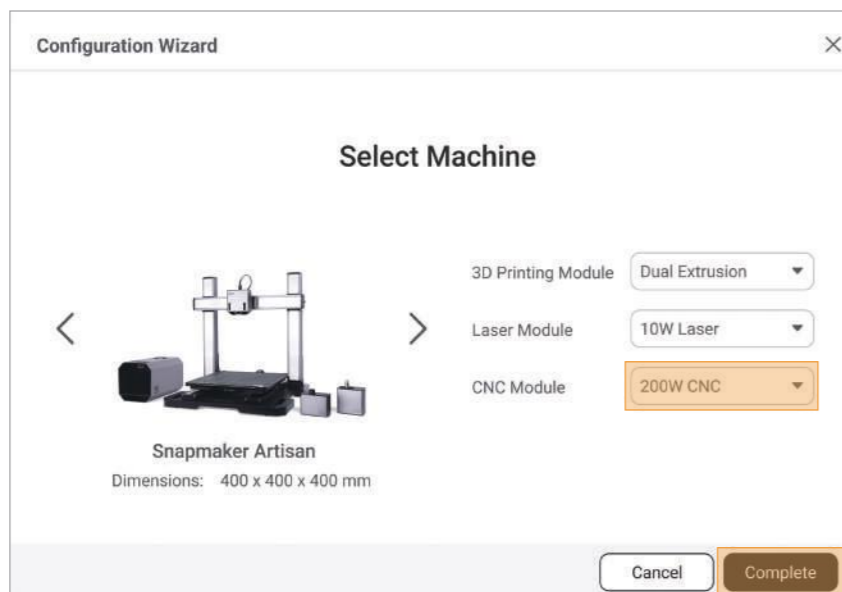

2. Launch Luban, select the language, machine model, and module type, and then click **Complete** to save the settings.



To change these settings later, click **Settings > Preferences** in the menu bar.

3. Ensure that your computer and machine are connected to the same Wi-Fi network, and take the following steps to connect Luban with your machine:

- On the Home page of Luban, click  to enter **Workspace**;
- On the **Connection** panel at the top left corner, click **Wi-Fi**;
- Click , select your machine from the drop-down list, and click **Connect**;
- Tap **Yes** on the Touchscreen to allow the connection.

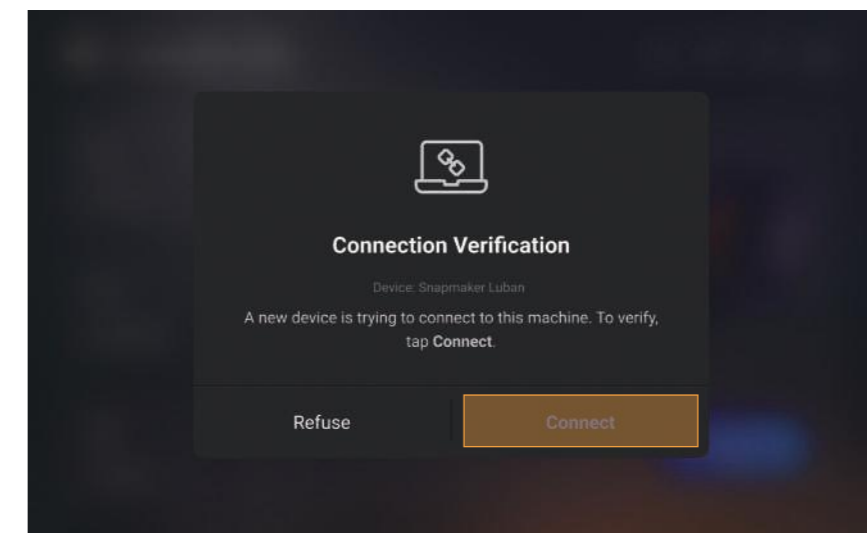
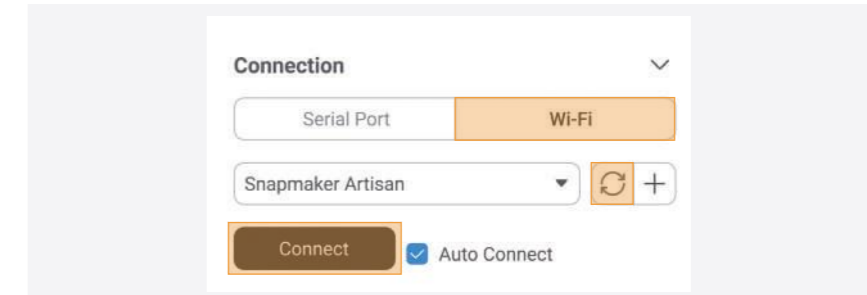

You can also click **+** and enter the IP address of your machine to manually connect it with Luban. To check the IP address, tap **Settings > About Machine** on the Touchscreen.

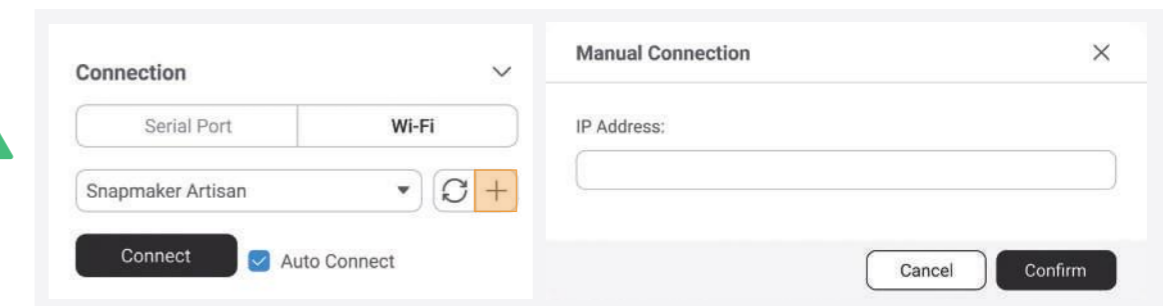

## 6.3.2 Generate the G-code File

1. At the top-left corner of Luban, click **Back** to return to the Home page. Then, click **CNC > 3-axis** to enter the **CNC G-code Generator**.

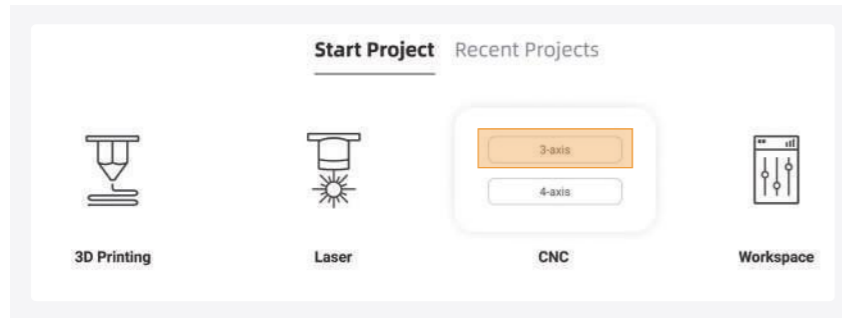

2. Follow the Beginner's Guide to get familiar with the basic operations. During this process, Luban will automatically load the test model and generate the G-code file.



If the Beginner's Guide does not pop up or quits unexpectedly, you can click **Help > Beginner's Guide** in the menu bar.



You can also click  to import your own files and configure the parameters.

3. Click **Export > Load G-code to Workspace**, and then click **Send to Device** on the **G-code Files** panel to send the G-code file to your machine via Wi-Fi.

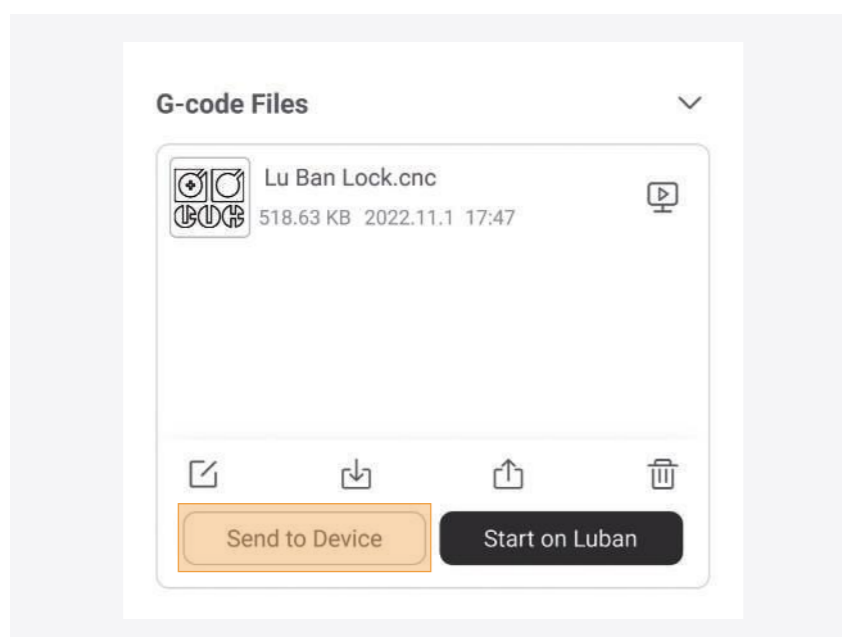
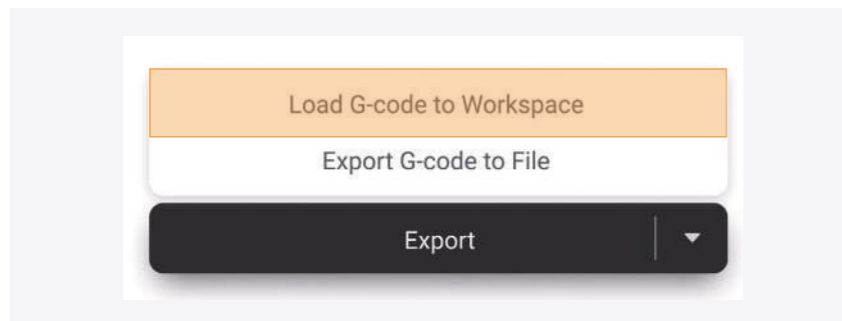

You can also send the G-code file to your machine via the USB flash drive or directly start the job on Luban.

For more detailed information, refer to our online User Manual: On the navigation bar of the Snapmaker official website, click **Support > Product Support > Snapmaker Artisan > User Manual**.

### 6.3.3 Set the Work Origin and Start Carving

#### How It Works: Work Origin

Determine where the carving will take place by setting the work origin. The work origin corresponds to the (0, 0) coordinate origin in the software.

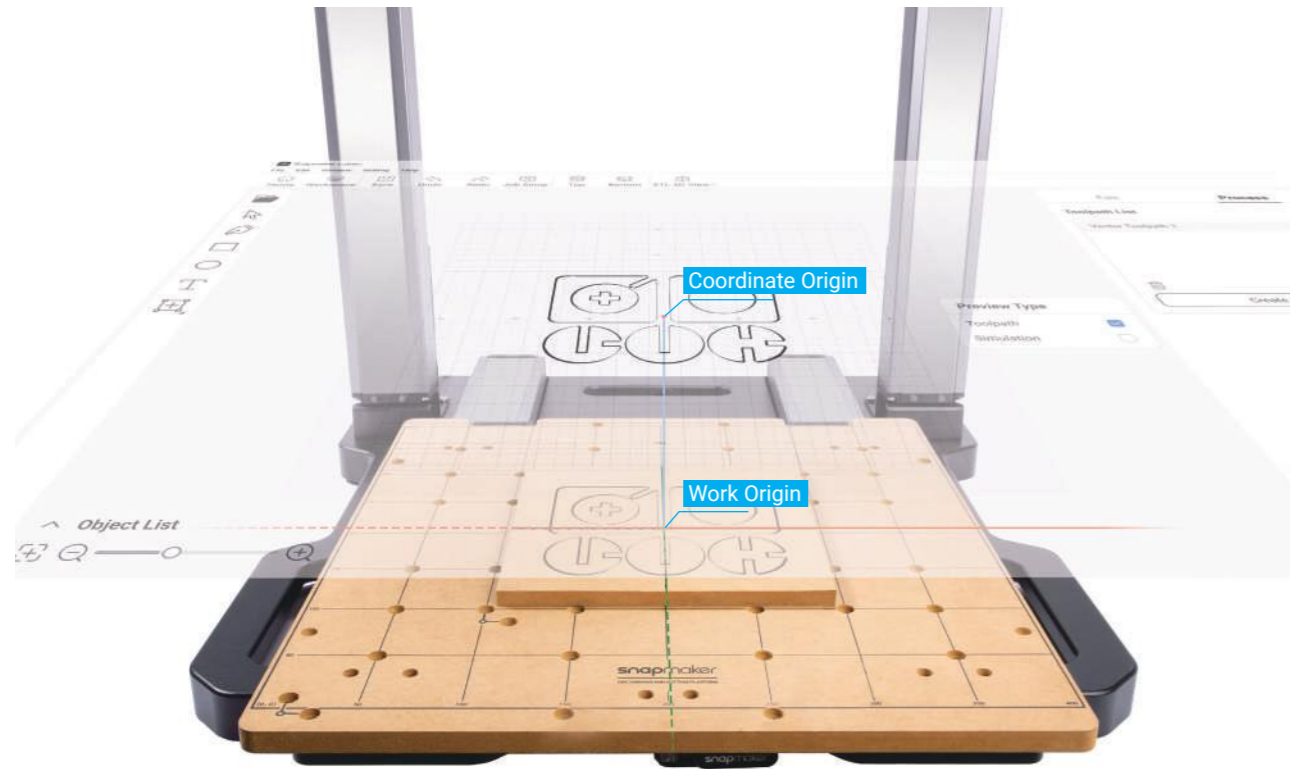

You can also set the work origin using the provided L bracket.



For more detailed information, refer to our online User Manual: On the navigation bar of the Snapmaker official website, click **Support** > **Product Support** > **Snapmaker Artisan** > **User Manual**.

1. After the G-code file is successfully sent to the machine, tap **Start** > **Files** > **Local**, select the received G-code file, and tap **Next**.



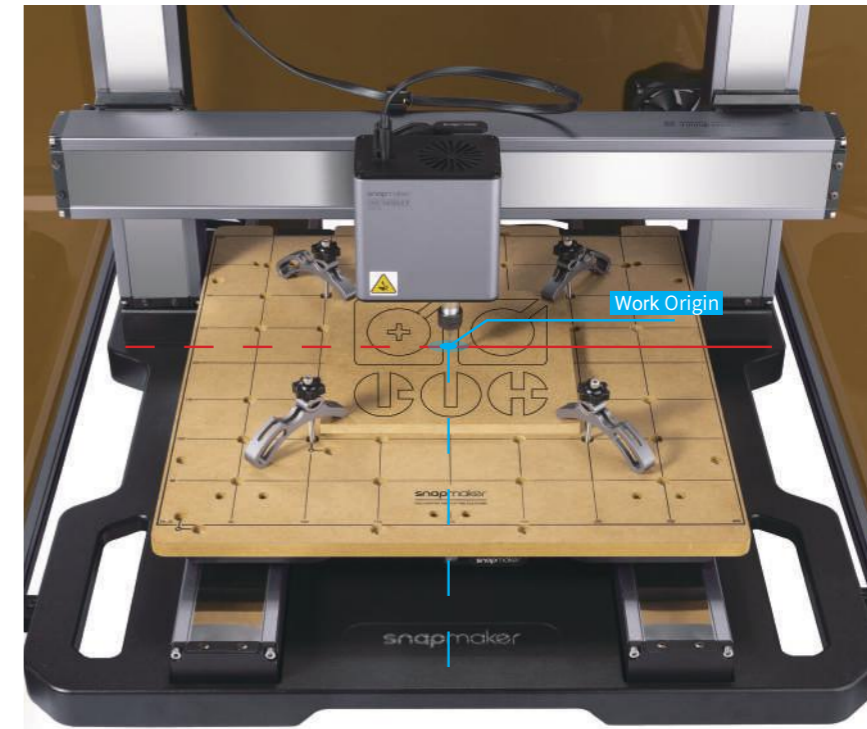
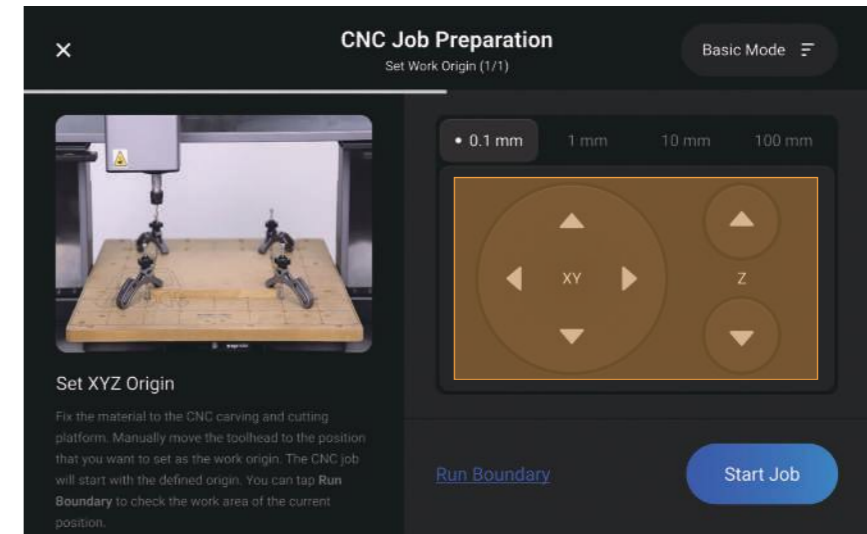

2. Move the CNC bit to where the work origin of the X and Y axes will be (in this case, we set the center of the image as the coordinate origin in the software). For easier observation, you can move the CNC bit closer to the material surface.



3. Tap **Z+** to lift the CNC bit until it is above the clamp set, and then tap **Run Boundary** to check if the work origin of the X and Y axes is set properly. If any part of the boundary trailed by the CNC bit goes outside of the material, or if the CNC Bit collides with any parts of the machine, reset the work origin of the X and Y axes, and run the boundary again.



 If the CNC bit runs into any part of the machine, press the emergency stop button on top of the Integrated Controller. After you have handled the emergency, rotate the emergency stop button clockwise to release it. Change the CNC bit if it is damaged due to the collision.

 If you have run the boundary with the CNC bit above the clamp set, you can lower the CNC bit to run the boundary again to locate the machining area more precisely. **But note:** Always make sure the CNC bit is above the material surface when running the boundary to avoid damaging the bit or the material.

4. Place the calibration card or a piece of A4 paper between the CNC bit and the material. You can set the work origin of the Z axis by tapping the **Z-** or **Z+** button to adjust the height of the CNC bit. If you can feel slight resistance when pulling out the calibration card and wrinkle the card when you push it forward, then the work origin of the Z axis is properly set.



5. In **Basic Mode**, the machine will take the coordinates of where the CNC module currently locates as the coordinates of the work origin. After you have confirmed the work origins of the X, Y, and Z axes are properly set, tap **Start** to start carving.

 Ensure that you place the Integrated Controller within easy reach. In case of an emergency, press the emergency stop button on top of the Integrated Controller to stop the job immediately. After you have handled the emergency, rotate the emergency stop button clockwise to release it.

 It is not recommended to turn on the exhaust fan of the Enclosure during a CNC process, or the dust and wood chips generated will attach to the inner surfaces of the Enclosure and the exhaust fan. To configure the settings of the Enclosure, refer to [section 3.2](#) of this guide.

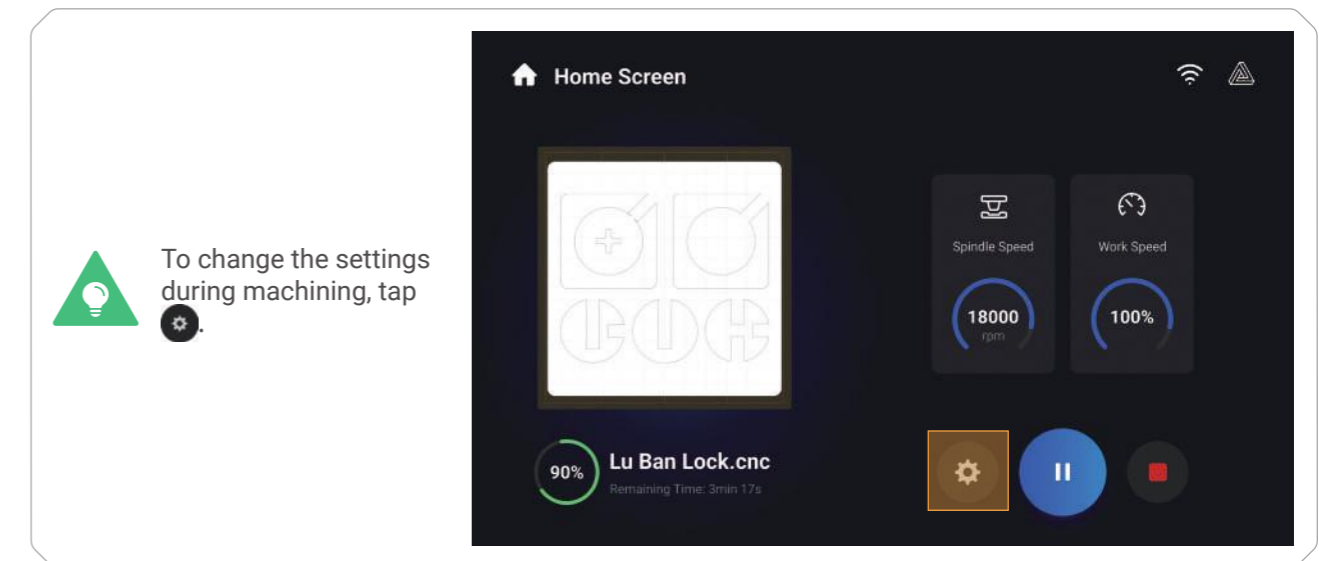



### 6.3.4 Clean the Finished Work and the Machine

1. Remove the clamp set from the CNC carving and cutting platform.



2. Clean the finished work and the machine with a dust collector.



After each CNC job, you need to clean the dust screen of the CNC Module and the machine surface with a dust collector or cotton swabs. Failure to clean the CNC Module after 150 hours of operation may result in motor dysfunction due to dust accumulation.



Do NOT rinse the CNC Module with water, and it is also not recommended to wipe the module with alcohol.

3. Remove the finished work with diagonal pliers.

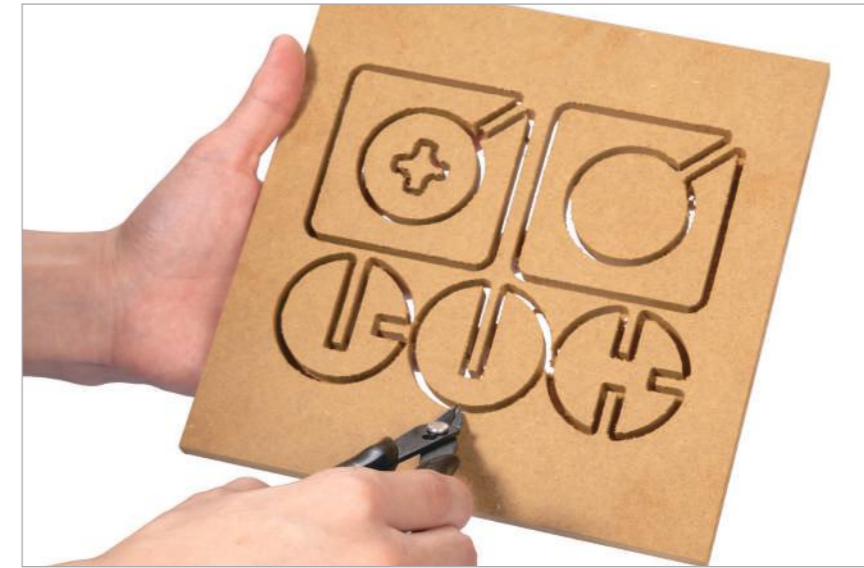

**Share!**

Share your finished work in our Facebook group and our forum.

# Maintenance

## 7.1 3D Printing

- 7.1.1 Clean the Glass Build Plate
- 7.1.2 Clean the Dust Screen
- 7.1.3 Clean the Nozzle
- 7.1.4 Clean the Extruder Gears
- 7.1.5 Store the Filament

## 7.2 Laser Engraving and Cutting

- 7.2.1 Clean the Laser Lens Protector

## 7.3 CNC Carving and Cutting

- 7.3.1 Secure the Nut
- 7.3.2 Clean the Dust Screen



## 7.1 3D Printing

### 7.1.1 Clean the Glass Build Plate

#### Remove the Filament Residues

##### Why

If the filament you use is highly viscous or the distance between the nozzle and the build plate is too close during printing, the filament might stick to the build plate surface. If not removed in time, it could affect your next print. As the residues build up, the build plate will also become more challenging to clean.

##### When

After each print.

##### How

1. Prepare the cleaning tool: the palette knife (in the toolbox);



2. Gently scrape the filament residues from the glass build plate with the palette knife.



When scraping, the angle between the palette knife and the glass build plate should be less than 30°, so as not to damage the surface of the printing plate.



If the filament residues are difficult to remove even with the palette knife, you can tap **Control > Heated Bed** on the Touchscreen, heat the bed to 50°C, and try scraping again. To prevent burns, it is recommended to wear gloves before scraping.

#### Remove the Adhesive

##### Why

Applying an appropriate amount of washable adhesive on the glass build plate before printing can enhance the first layer adhesion of the print. However, if not removed after printing, the residual adhesive on the build plate might affect your next print.

##### When

Every time after you apply the adhesive on the build plate.

##### How

1. Prepare the cleaning tool: water and the wiping cloth (in the Quick Start Guide kit);



2. Power off the machine;

3. Moisten the wiping cloth with water and wipe off the adhesive from the build plate.

#### Remove the Grease and Dust

##### Why

Our hands or other body parts might leave a small amount of natural oil and dust on the plate surface when touching the glass build plate. Besides, the dust in the air will also adhere to the plate. If not removed in time, the first layer adhesion of the print might be weakened.

##### When

At least once every two weeks.

##### How

1. Prepare the cleaning tool: water and the wiping cloth (in the Quick Start Guide kit);

2. Power off the machine;

3. Moisten the wiping cloth with water and gently wipe the build plate surface until there is no obvious grease, dust, or other stains.



If it is difficult to remove the grease with water, you can try the ethyl alcohol.

## 7.1.2 Clean the Dust Screen

### Why

The dust in the air will adhere to its dust screen on both sides of the Dual Extrusion Module in daily use. If not removed in time, the accumulated dust may hinder heat dissipation and affect the working efficiency of the module.

### When

At least once every two weeks.

### How

1. Prepare the cleaning tool: a cotton swab (or tissues) and water;



2. Power off the machine and detach the Dual Extrusion Module from the machine;

3. Moisten a cotton swab with water, and stick it inside the air inlet to clean the dust screen until there is no dust or water.



The cotton swab is a single-use tool. If there is still dust remaining on the dust screen after you clean it once, take a new cotton swab and repeat Step 3 to clean it again.

## 7.1.3 Clean the Nozzle

### Why

During the 3D printing process, some of the extruded filament may stick to the nozzle surface. After the nozzle cools, these filament residues will solidify on its surface. If not cleaned in time, they may cause nozzle jams or leave dark marks on your next print.

### When

At least once every two weeks.

### How

1. Prepare the cleaning tool: the wire brush (in the toolbox);



2. Power on the machine, tap **Control** > **Filament** on the Touchscreen, and heat the target nozzle to 200°C ;



3. After the nozzle is heated, scrape off the filament residue from the nozzle surface with the wire brush.





Be careful of the hot nozzle surface!

Do NOT scrape against the black thermal insulating casing during cleaning.



## 7.1.4 Clean the Extruder Gears

### Why

Strong friction will be generated between the extruder gears and the filament during printing, due to which lots of small shavings will be ground away from the filament. If not cleaned regularly, the teeth of the extruder gears may be flattened by the accumulated shards and particles, which will inhibit the gears from gripping and pushing the filament through the hot end and finally affect the printing results.

### When

At least once every two weeks.

### How

1. Prepare the cleaning tool: a banister brush (not provided);
2. Unload the filament from the module;
3. Power off the machine, open the front cover of the module, and press the extruder buckle downwards to expand the dual-gear extruder;



4. Clean the filament shavings from the extruder gears with the banister brush.

## 7.1.5 Store the Filament

Most 3D printing filaments (especially PA, PVA, and PETG) absorb moisture from the air, while printing with wetted filament is likely to clog the nozzles or affect the printing quality. Therefore, the filament should be used up within one month once unpacked.

If a spool of filament will be left unused for a long time, take the following steps to store it properly:

1. Unload the filament from the module;
2. Store the filament in a vacuum-sealed bag filled with desiccant;
3. Mark the unpacking date on the bag.

## 7.2 Laser Engraving and Cutting

### 7.2.1 Clean the Laser Lens Protector

#### Why

Dust and grease may accumulate on the laser lens protector over time, which will significantly decrease the engraving and cutting capability of the laser. Therefore, you need to clean the laser lens protector to recover the engraving and cutting capability of the module.

#### When

At least once every week.

#### How

1. Prepare the cleaning tools: a cotton swab and the ethyl alcohol (not provided);



The purity of the ethyl alcohol should be at least 75%. The 99% ethyl alcohol works best.

2. Power off the machine and detach the 10W Laser Module from the machine;

3. Moisten a cotton swab with ethyl alcohol, and stick it into the air concentrator hood to wipe the surface of the laser lens protector from center to margin clockwise, until there is no dust, grease, or water.



The cotton swab is a single-use tool. If there is still dust or grease remaining on the laser lens protector after you wipe it once, take a new cotton swab and repeat Step 3 to clean it again.

If the original laser lens protector is damaged, you can replace it with the spare one (included in the package).



For detailed instructions, refer to our online User Manual: On the navigation bar of the Snapmaker official website, click **Support** > **Product Support** > **Snapmaker Artisan** > **User Manual**.

## 7.3 CNC Carving and Cutting

### 7.3.1 Secure the Nut

#### Why

The nut on the CNC carving and cutting platform may fall off after long-time use or under improper operation. When this happens, you need to glue it back.

#### How



Before the operation, wear protective gloves to prevent contact with the toxic AB glue and wear protective equipment to avoid inhaling volatile toxic gases.

1. Prepare the cleaning tools: tweezers, a brush, the AB glue, and protective gloves (the latter three not provided);
2. Clear the sawdust on the nut with the brush;



3. Squeeze out the A glue and B glue in a 1:1 proportion;



Do NOT mistakenly screw the lid of the A glue on the B glue.

4. Mix the A glue with the B glue with the mixing stick, and stir them evenly;

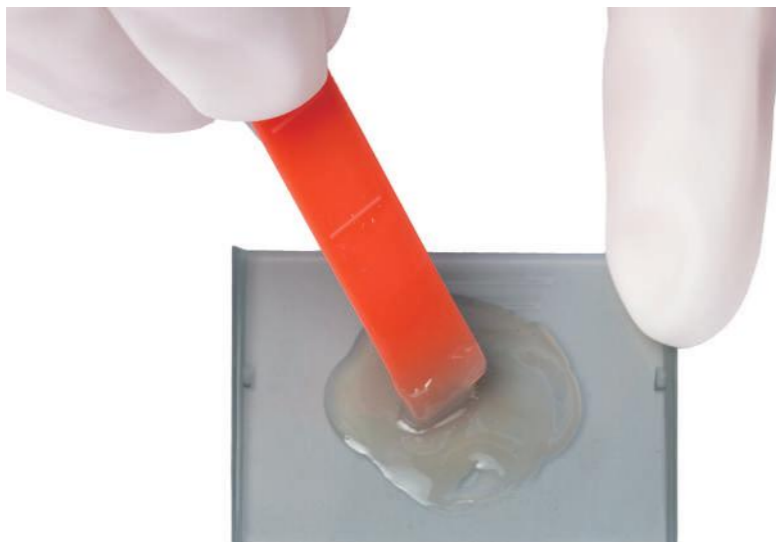

5. Apply the mixed glue to the screw thread of the nut;



6. Tweeze the nut back into the hole of the CNC carving and cutting platform, and press it for a while. Then, wait for at least 24 hours before reuse to ensure that the mixed glue is cured.

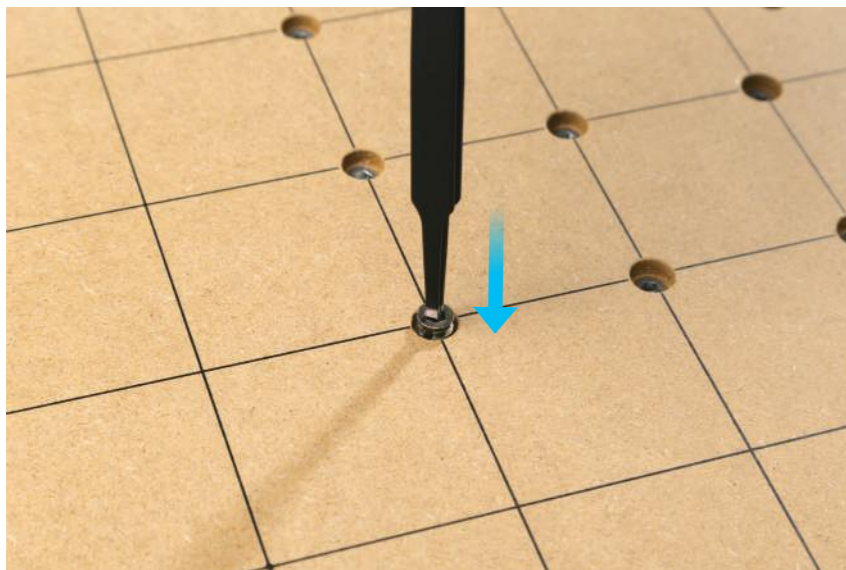

## 7.3.2 Clean the Dust Screen

### Why

In addition to cleaning the dust screen of the CNC module and the surface of the machine after each operation with a vacuum cleaner, you can also use a cotton swab to clean the dust screen of the CNC module. Failure to clean it effectively may cause the motor of the CNC module to fail due to blockage.

### When

After every three CNC jobs.

### How

1. Prepare the cleaning tool: a cotton swab (or tissues) and water;



2. Power off the machine and detach the 200W CNC Module from the machine;

3. Moisten a cotton swab with water and stick it inside the air inlet on top of the module to clean the dust screen until there is no dust or water.



The cotton swab is a single-use tool. If there is still dust remaining on the dust screen after you wipe it once, take a new cotton swab and repeat Step 3 to clean it again.

# Resources

This guide is subject to update.

You can obtain its latest version at our Support Center: select **Snapmaker Artisan > Quick Start Guide**.

<https://support.snapmaker.com>

You can also get a detailed User Manual at our Support Center: select **Snapmaker Artisan > User Manual**.

<https://support.snapmaker.com>

We are here for you whenever you need general information or technical support:

[support@snapmaker.com](mailto:support@snapmaker.com)

For any sales inquiries:

[sales@snapmaker.com](mailto:sales@snapmaker.com)

For product purchases:

<https://shop.snapmaker.com>

Share anything you want with other Snapmaker users in our forum:

<https://forum.snapmaker.com>

